

**THE FUTURE
OF PROFESSIONAL
ACHIEVEMENT**

中国·上海市普陀区金沙江路1678号6号楼501室

Add.: 6-501, Oasis Mid. Ring Center, 1678 Jinshajiang Rd.,
Putuo Dst., Shanghai 200333, P.R.China

江苏省无锡市滨湖区胡埭镇棕竹路2号 (工厂地址)

Factory Add.: 2 Zongzhu Rd., Hudai Town, Binhu Dst., Wuxi,
Jiangsu 214161, P.R.China

Services: [4008201358](tel:4008201358) | Tel: 0086-21-61808099 | Fax: 0086-21-62595096 | E-mail: roken@roken.com.cn | [Http://www.roken.com.cn](http://www.roken.com.cn)

2024年11月 第五版

上海柔肯液压科技有限公司
SHANGHAI ROKEN HYDRO-TECH CO.,LTD.

ROKEN CHINA





Contents

2	公司简介及业务范围	Company profile / Business of ROKEN HYDRO-TECH
4	厂区简介/资质认证/合作伙伴	Factory introduction / Qualification and partners
6	RM RM-e RA型标准液压装置/德国DIN标准液压站	RK, RA, RM, RM-e, RA Series hydraulic power units / DIN Standard hydraulic stations
8	液动力单元/比例液压系统	Mini hydraulic power units / Proportional control hydraulic systems
10	高压水系统 / 扩管胀型机液压系统	High-Pressure water systems / Hydraulic systems for Pipe expanding machine
12	静音泵站 / 隧道盾构机液压站	Silent HPU / Hydraulic systems for TBM
14	压机液压系统 / 电子电路板层压机液压系统	Hydraulic systems for press machine / Hydraulic system for circuit board laminator
16	汽车工业液压系统	Hydraulic systems for automotive industry
18	港口机械液压系统 / 游乐设备液压系统	Hydraulic systems for Port machinery / Amusement equipment
20	船舶液压站	Hydraulic systems for Shipping industry
22	组合机床液压站 / 轮胎硫化机液压站	Hydraulic systems for Combined machine tools / Hydraulic systems for Tyre vulcanizer
24	冶金液压系统	Hydraulic systems for metallurgical industry
26	环卫设备及配套液压系统/ 石油机械行业液压系统	Sanitation machinery and Hydraulic systems / Hydraulic systems for Petroleum machinery industry
28	卡特彼勒液压缸测试系统 / 英格索兰液压测试系统	Hydraulic cylinder testing system for Caterpillar / Hydraulic testing systems for Ingersoll Rand
30	三一减速机 and 回转支承测试台 / 液压元件测试台	Reducer / Slewing bearing experimental bench / Hydraulic parts testing bench
32	发动机测试台 / 库卡机器人液压系统	The engine experimental platform / Hydraulic systems for KUKA robot
34	电气控制系统	Electrical control systems
36	液压缸	Hydraulic cylinder
38	辅件 / 液压集成阀组件	Hydraulic accessories / Hydraulic pile-up valve modules
40	中国南极科考队低温加油泵站和雪橇	Refueling pump stations under the low temperature and sledges for Chinese Antarctic Scientific Expedition
42	客户案例	Client cases



ROKEN HYDRO-TECH 的业务：

- ▶ 液压系统的设计和制造
- ▶ 专用电器控制系统的设计和制造
- ▶ 液压油缸、活塞式蓄能器的设计和制造
- ▶ 专用液压元件的制造和销售
- ▶ 进口液压和电子元件的销售
- ▶ 技术支持与产品售后服务
- ▶ 机械设备研发与制造
- ▶ 钢结构件加工

Business of ROKEN HYDRO-TECH:

- ▶ Design and manufacturing of hydraulic systems
- ▶ Design and manufacturing of specialized electrical control systems
- ▶ Design and manufacturing of hydraulic cylinders and piston accumulators
- ▶ Manufacturing and sale of specialized hydraulic components
- ▶ Sale of imported hydraulic and electronic components
- ▶ Technical support and after-sale service
- ▶ Research and Manufacturing of Machines
- ▶ Processing of steel structural parts

上海柔肯液压科技有限公司

SHANGHAI ROKEN HYDRO-TECH CO., LTD.

Hydraulic is a technique which generates force and movement through controlling liquid with the pressure. Depending on its extensive design experience in the field of motion and control technology, **ROKEN HYDRO-TECH** has provided customers with innovative components and complete system, and it is the best partner in this field. **ROKEN HYDRO-TECH** works with its partners to develop new products and ideas, provide customers with its reliable products and help them improve productivity and profitability.

ROKEN HYDRO-TECH has accumulated rich knowledge and experience in the field of motion and control, which can not only help you increase production significantly, but also help you control production costs and management costs. We are willing to explore technical solutions with you to help you succeed.

The market of **ROKEN HYDRO-TECH** includes traditional industry, architecture, agriculture, Environment-green energy, metallurgy, mining, shipping and etc., and it has a leading position in the hydraulic system of amusement equipment, plastics machinery, environmental sanitation machinery, mining machinery, machinery tool, testing equipment, metallurgical equipment and ship crane. Besides, we also provide the convenient pre-sale and after-sale service for you. From traditional industry to walking machinery, and from single component to system solution, **ROKEN HYDRO-TECH** will be your loyal consultant and reliable partner in hydraulic product selection.

ROKEN HYDRO-TECH is ISO 9001:2015 certified.

ROKEN HYDRO-TECH is the nominated OEM of hydraulic system of YUKEN Kogyo Co., Ltd, it has manufactured over 100 kinds of power units which is more than 300 sets for YUKEN, and it is also the agent of YUKEN in P.R.China.

ROKEN HYDRO-TECH is the authorized distributor of PARKER HANNIFIN Corporation.

ROKEN HYDRO-TECH is the authorized distributor of CASAPPA, Italy.

ROKEN HYDRO-TECH is the authorized distributor of Hydraulic valves of OLEOWEB, Italy.

ROKEN HYDRO-TECH is the authorized distributor of mini control system of MCS, Italy.

ROKEN HYDRO-TECH is the authorized distributor of quick release couplings of DNP Industriale Srl, Italy.

ROKEN HYDRO-TECH is the authorized distributor of steel fitting of Rastelli Raccordi s.r.l., Italy.

液压是控制带有压力的液体来产生作用力和运动的技术。**ROKEN HYDRO-TECH**凭借在运动和控制技术领域广博的设计经验，为用户提供创新的组件和完整成套系统，是用户在该领域的最佳合作伙伴。**ROKEN HYDRO-TECH**与合作伙伴携手，不懈开发新的产品和新的思路，为客户提供可靠的产品，帮助他们提高生产效率和赢利能力。

ROKEN HYDRO-TECH在运动和控制领域积累了丰富的知识和经验，不仅能够助您显著增加产量，同时可以帮助您控制生产成本和管理成本。我们愿与您一起探索技术解决方案，助您铸就成功。

ROKEN HYDRO-TECH的市场包括传统工业、建筑、农业、环境-绿色能源、冶金、矿山和船舶等等，在游乐设备、塑料机械、环卫机械、矿山机械、机床、测试设备、冶金机械及船舶方面的液压系统具有行业领先地位。我们为您提供快捷便利的售前和售后服务，从传统工业到行走机械，从单个元件到系统解决方案，**ROKEN HYDRO-TECH**是您在液压产品选择的忠实顾问和可靠伙伴。

ROKEN HYDRO-TECH通过 ISO 9001:2015 质量认证体系；

ROKEN HYDRO-TECH是日本油研工业株式会社（YUKEN）液压系统的代工厂，已累计为YUKEN制作液压站100个品种300余台；是日本YUKEN在中国大陆地区的代理商；

ROKEN HYDRO-TECH是派克-汉尼芬公司(PARKER)官方授权分销商；

ROKEN HYDRO-TECH是意大利CASAPPA公司官方授权分销商；

ROKEN HYDRO-TECH是意大利OLEOWEB液压阀等产品授权代理商；

ROKEN HYDRO-TECH是意大利MCS测压接头等产品授权代理商；

ROKEN HYDRO-TECH是意大利DNP液压快换接头产品授权代理商；

ROKEN HYDRO-TECH是意大利Rastelli液压管接头产品授权代理商；



ROKEN HYDRO-TECH 生产制造基地位于江苏省无锡市滨湖区胡埭镇，紧邻S342省道，交通便利。厂区建筑面积12,000平方米，配电650KVA，行车起重高度/重量为10M/20T。









ROKEN HYDRO-TECH 的设备：拥有250T数控折弯机、8X2500剪板机、卷板机、1500X6000激光切割机床、1500x6000数控等离子/火焰切割机床、数控带锯床等板材加工设备；交流弧焊机、直流弧焊机、氩弧焊机、气体保护焊机、等离子切割机、仿型切割机等焊割设备；喷砂-喷漆-喷塑-烤漆生产线等表面处理设备；摇臂钻床、钻铣床、车床、磨床、数控机床和进口加工中心等机械加工设备；进口胶管扣压机、进口切管机、压力测试机、胶管清洗机及液压胶管总成加工设备；3D伺服弯管机、切管机、卡套预压机等硬管加工设备；液压清洗台、液压电气伺服试验台、数字检测仪器等液压系统检验设备。

ROKEN HYDRO-TECH 的人力资源：拥有液压高级工程师、结构工程师、液压系统匹配工程师、电器及软件编程工程师、中高级技师技工等100名员工

ROKEN HYDRO-TECH 的优势：

- ▶ 液压系统依照日本YUKEN标准、美国PARKER标准生产，精工细做，每款产品都是经典之作
- ▶ PARKER、YUKEN、REXROTH、ATOS等进口液压元件及液压辅件的库存备货
- ▶ COMPANY POSITIONING FOR THE FUTURE 品质保证
- ▶ 超强的液压及电控系统设计团队
- ▶ 快速的交货期
- ▶ 完善的质量管理体系和售后服务体系

公司资质及合作伙伴 QUALIFICATION AND PARTNERS

<p>代理商 Agent</p> 	<p>分销商 Distributor</p> 	<p>分销商 Distributor</p> 
<p>代理商 Agent</p> 	<p>快速接头代理商 Agent of Quick Couplings</p> 	<p>管接头代理商 Agent of Connector</p> 
<p>测压接头代理商 Agent of testing point</p> 	<p>橡胶软管代理商 Agent of Rubber Hoses</p> 	<p>过滤器代理商 Agent of Filters</p> 



厂区简介 FACTORY INTRODUCTION

ROKEN HYDRO-TECH is located in Hudai Town, Binhu District, Wuxi City, Jiangsu Province, which is close to S342 provincial road, convenient transportation. It covers an area of 12,000 square meters, power distribution 650kva, crane lifting height / weight is 10m / 20t.

Equipments: With the development of company, now we have complete series of advanced production equipment from home and abroad such as 250T bending machine, 8X2500 plate shearing machine, rolling machine, 1500x6000 laser cutting machine, 1500x6000 CNC plasma / flame cutting machine, CNC band sawing machine and other plate processing equipment; AC arc welding machine, DC arc welding machine, argon arc welding machine, gas protection welding machine, plasma cutting machine, imitation cutting machine and other welding and cutting equipment; sand blasting-spray paint-powder coating-baking finish production line and other surface treatment equipment; radial drilling machine, drilling and milling machine, lathe, grinder, CNC machine and imported processing center; imported rubber hose assembly processing equipment such as rubber hose buckle press, imported pipe cutting machine, pressure testing machine, hose cleaning machine and etc., 3D servo pipe bending machine, pipe cutting machine, sleeve pre-press and other hard pipe processing equipment. Inspection equipment for hydraulic system: hydraulic cleaning table, hydraulic and electrical servo test bench, digital inspection instruments and etc..

Human resources: We have experienced hydraulic senior engineers, structural engineers, hydraulic system matching engineer, electrical and software programming engineer and senior technicians, 100 employees in total.

Advantages:

- ▶ Hydraulic systems are all manufactured according to the standards of PARKER and YUKEN. Each product is a classic.
- ▶ Inventory of imported hydraulic components and accessories of various brands, such as PARKER, YUKEN, REXROTH, ATOS, etc.
- ▶ Quality guarantee from COMPANY POSITIONING FOR THE FUTURE
- ▶ Strong design team of hydraulic systems and electrical control systems
- ▶ Faster delivery time
- ▶ Perfect quality management system and after-sale service system

RK 型标准液压装置

RK series hydraulic power units

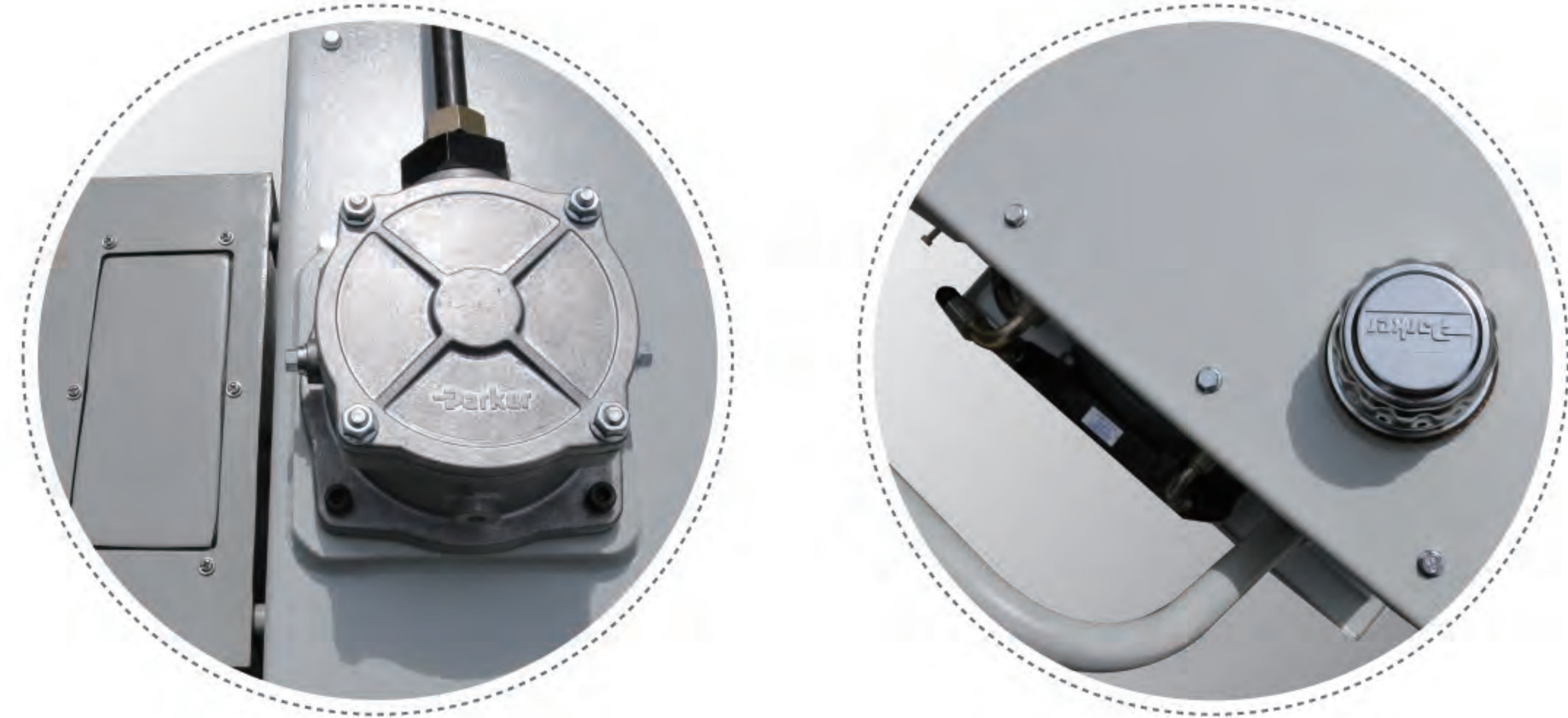

RA, RM, RM-e 型标准液压装置

RA, RM, RM-e series hydraulic power units

ROKEN 的标准液压装置，是适应时代要求而开发的省资源、节能、低噪声产品。追求使用方便，具备有丰富的品种，使用户能根据自己的需要来选定型号。

- 低噪声
装载低噪声的变量柱塞泵、变量叶片泵，同时在油箱的构造和配管等方面考虑的很周到，所以噪声低，运转时音质良好。
- 节能、发热量小
由于采用了高效率的压力补偿型变量柱塞泵，功率损耗少，所以能节约电力。

- 丰富的品种
为了能让你选择最合适的产品，将泵、油箱的容积和电机功率组成29种不同的型号，备有基础板等21种任选。
- 全品种、带有压力调节螺钉
全品种、带有流量调节螺钉
- 交货期短
因采用了标准化的装置，交货期短。
- 控制回路的组成很容易
因为按需要可安装叠加阀，所以能很容易地组成各种回路。

德国 DIN 标准液压站

DIN standard hydraulic power units

全系列油箱及配件按 DIN 标准尺寸制作。
All series of tanks and accessories are manufactured according to DIN standard dimensions.

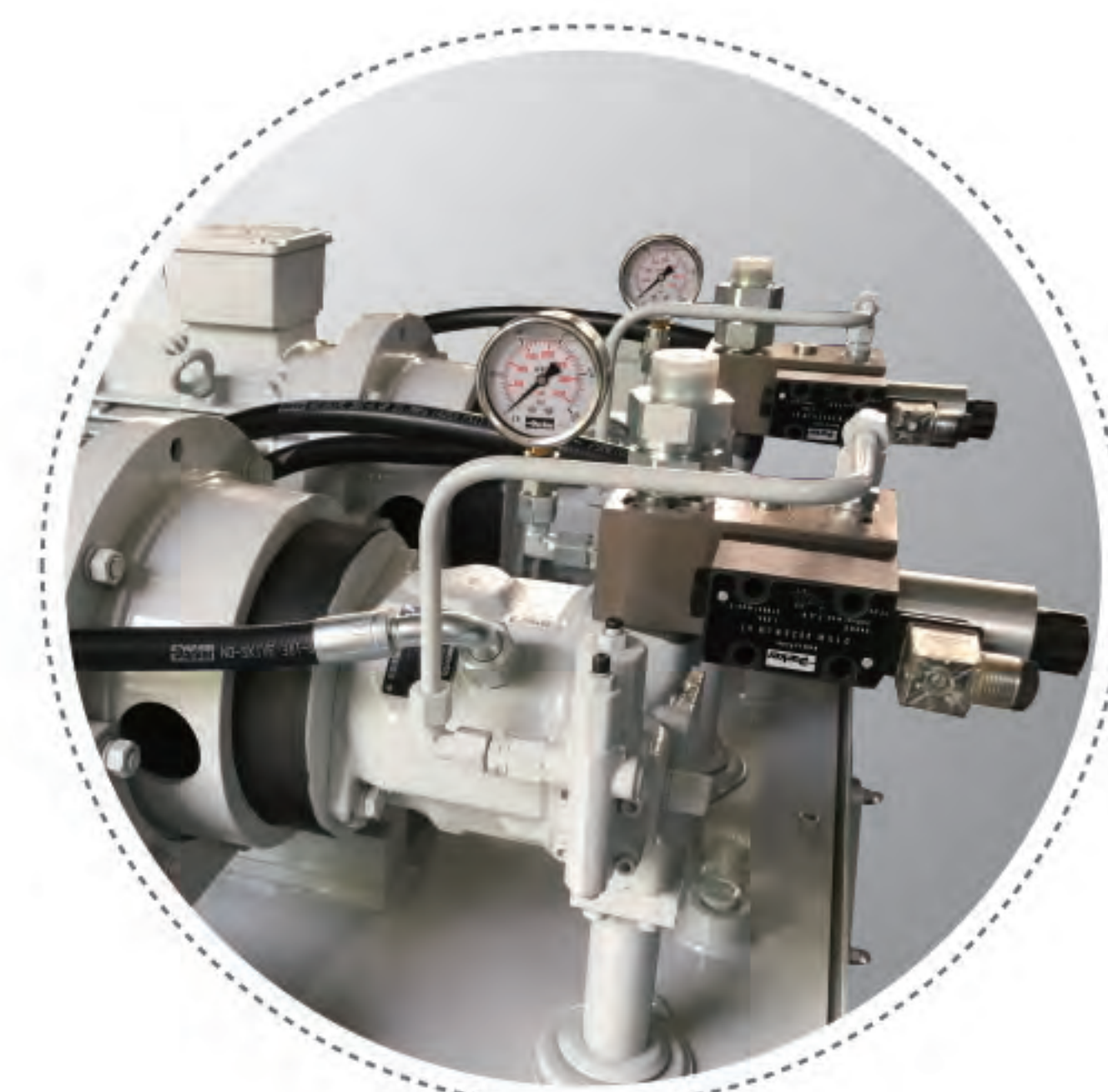

● 泄压及安全阀模块
Module of decompression and safety valves



● SIEMENS 品牌电机
SIEMENS motor

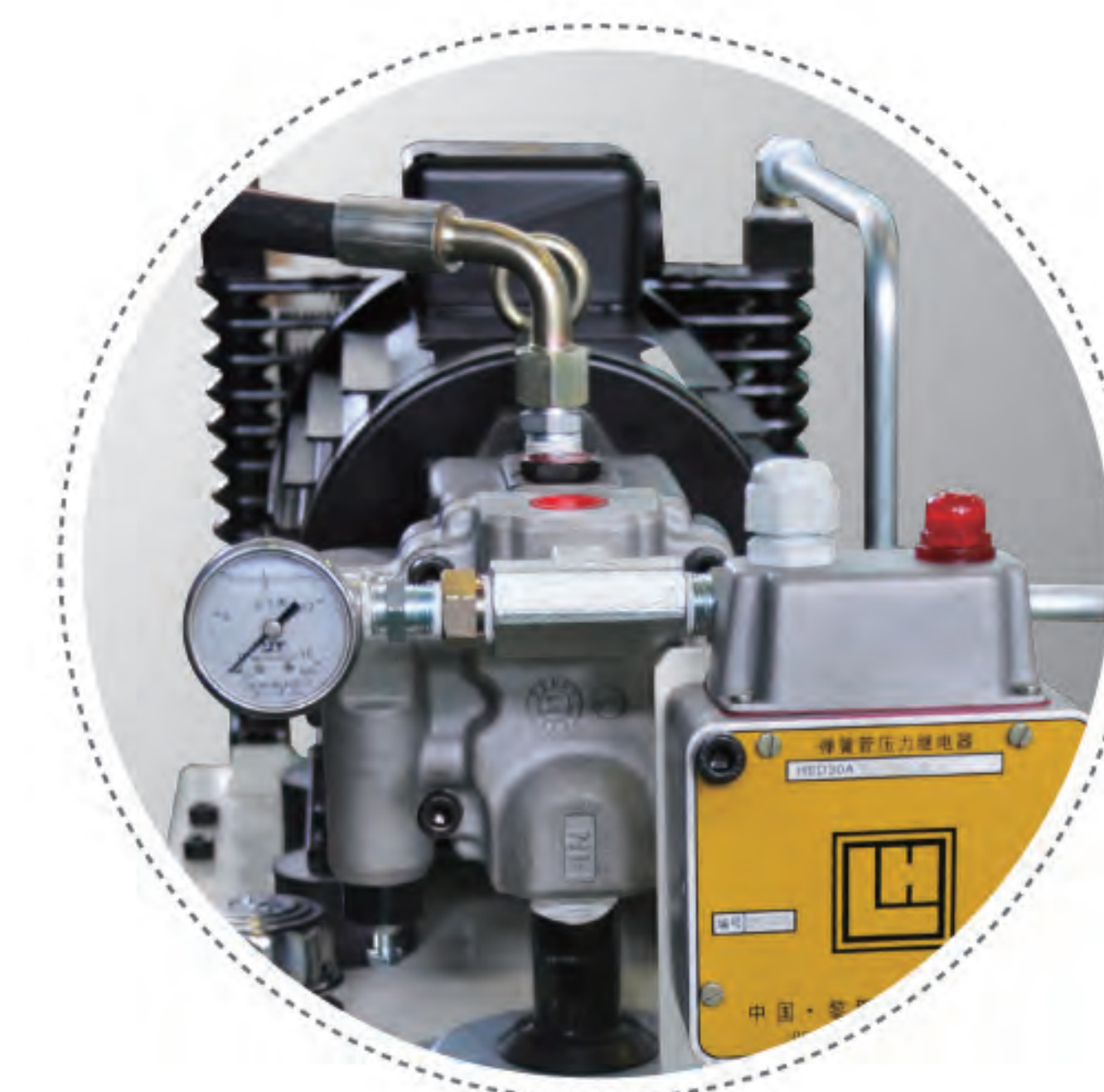

ROKEN standard hydraulic power units are the products of energy-saving and low noise that developed according to the requirement of the times. Easy to use and wide assortment of models so that the customer could choose the model according to their demands.

● Low noise

Low Noise Hydraulic Power Units feature structure-borne sound decoupling with reasonable oil tank and piping structures and low-noise variable displacement piston pump and vane pump so that no significant sound is emitted.

● Energy saving

Substantial energy saving of hydraulic units has been achieved by equipped with a high-efficiency variable displacement piston pump of pressure compensation type.

● Wide assortment of models

A total of 29 models are available according to the combination of the built-in pump, the reservoir capacity, and the motor output, so that the most suitable model can be selected.

● Short-term delivery

Use of standardized devices to shorten the delivery time.

● Facilitating the configuration of the control circuit

With 21 different options (incorporating a base plate, etc.), any hydraulic circuit can be easily configured by stacking the modular valves.



液压动力单元 Hydraulic power units



● 各类品牌阀可选
All kinds of brand valves can be selected

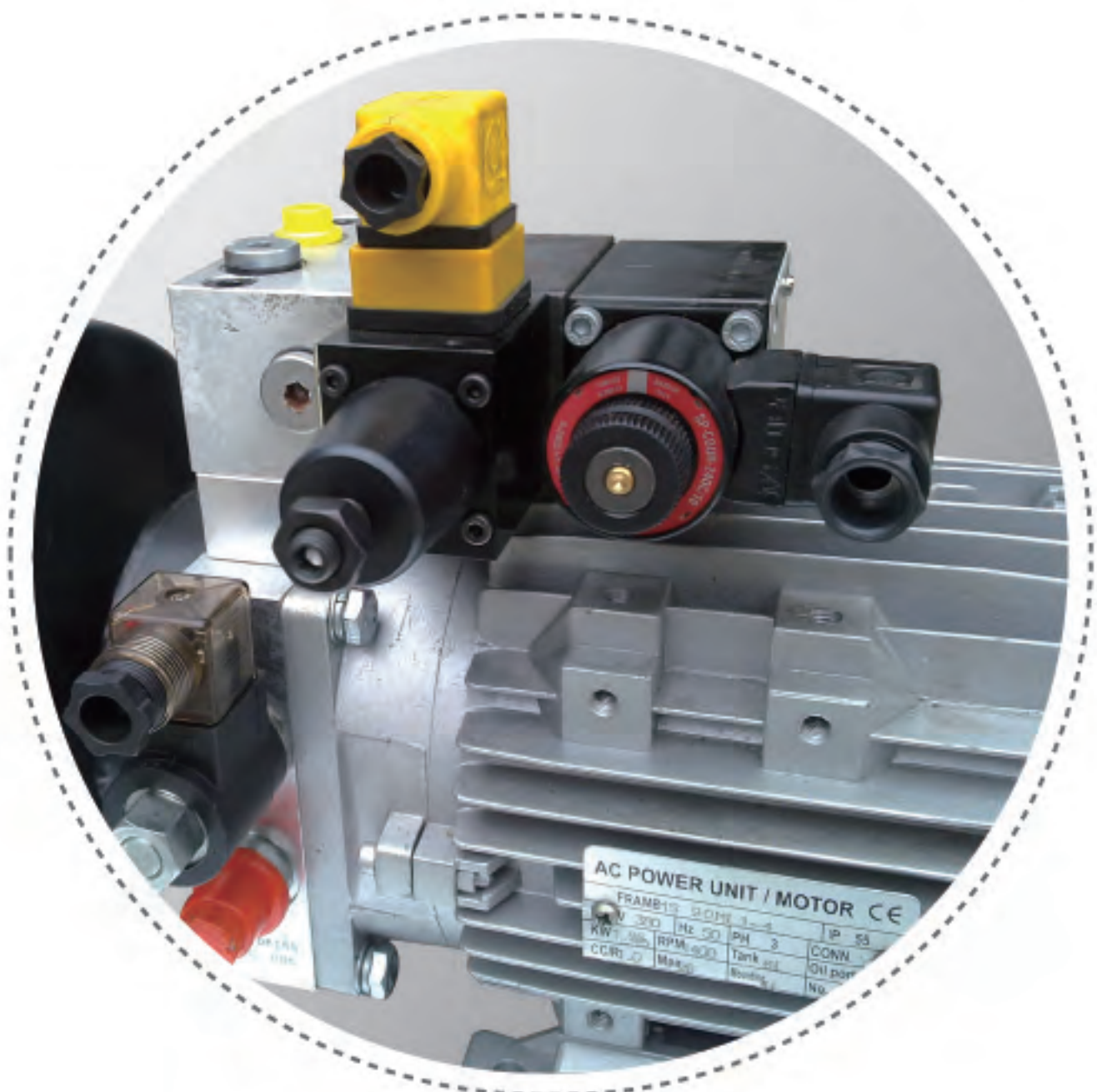

● 液压阀扩展单元
Extension unit of hydraulic valves

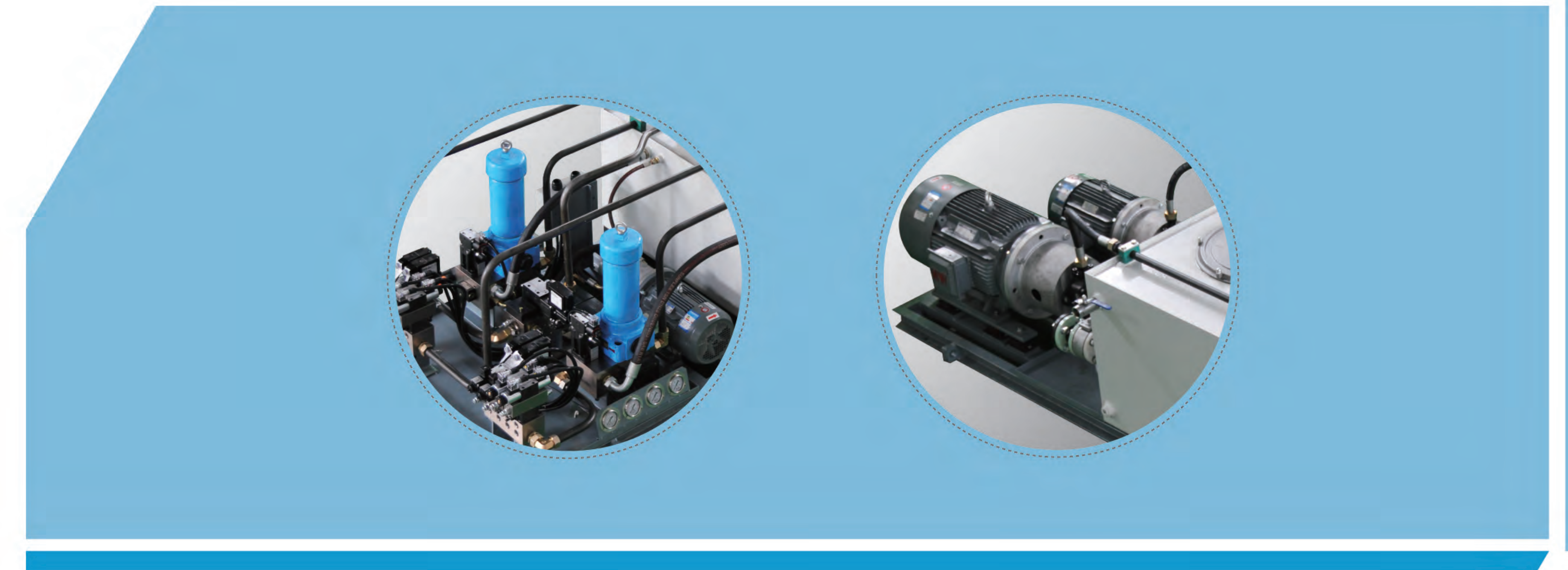

比例液压系统 Proportional hydraulic systems

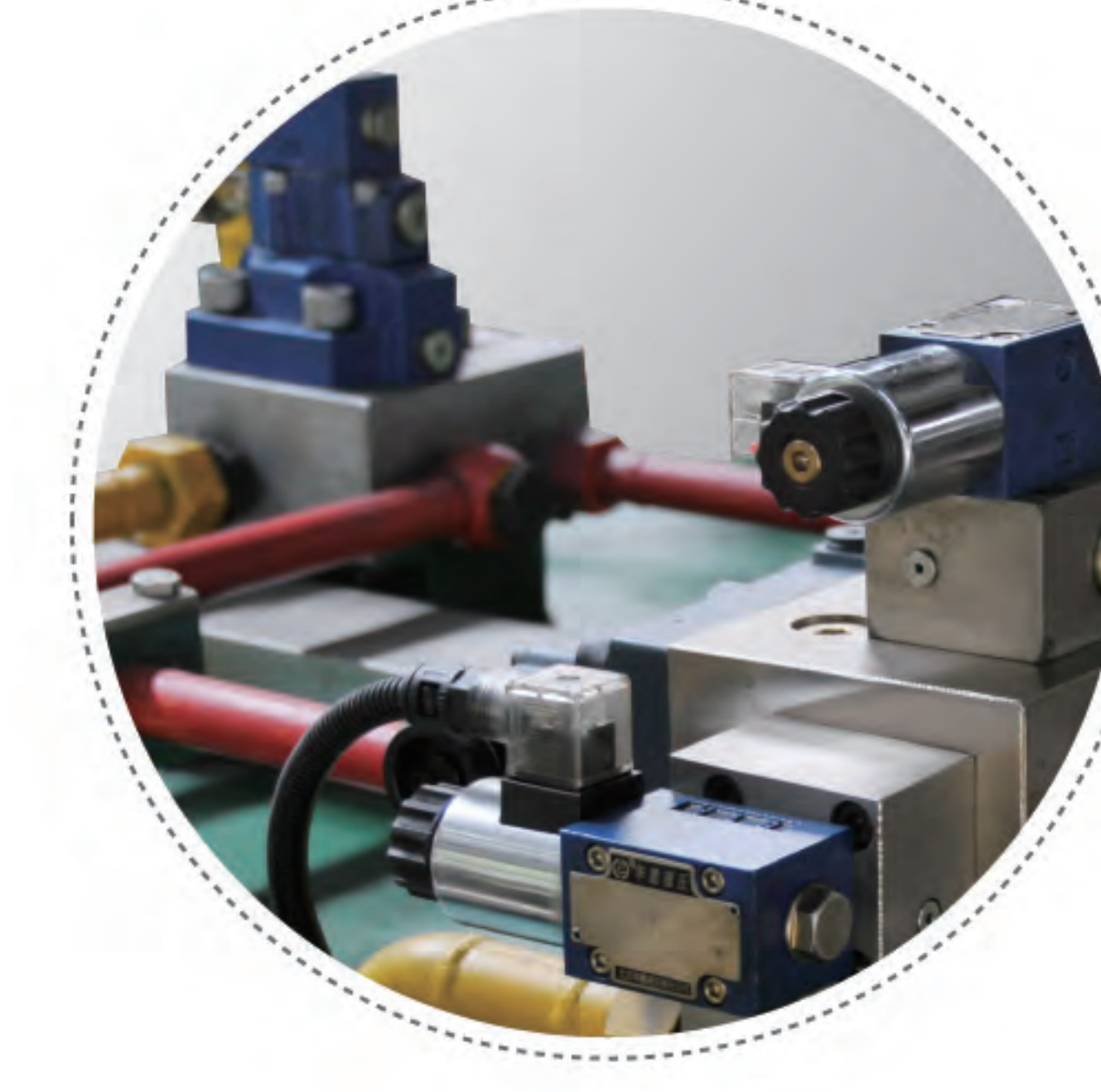
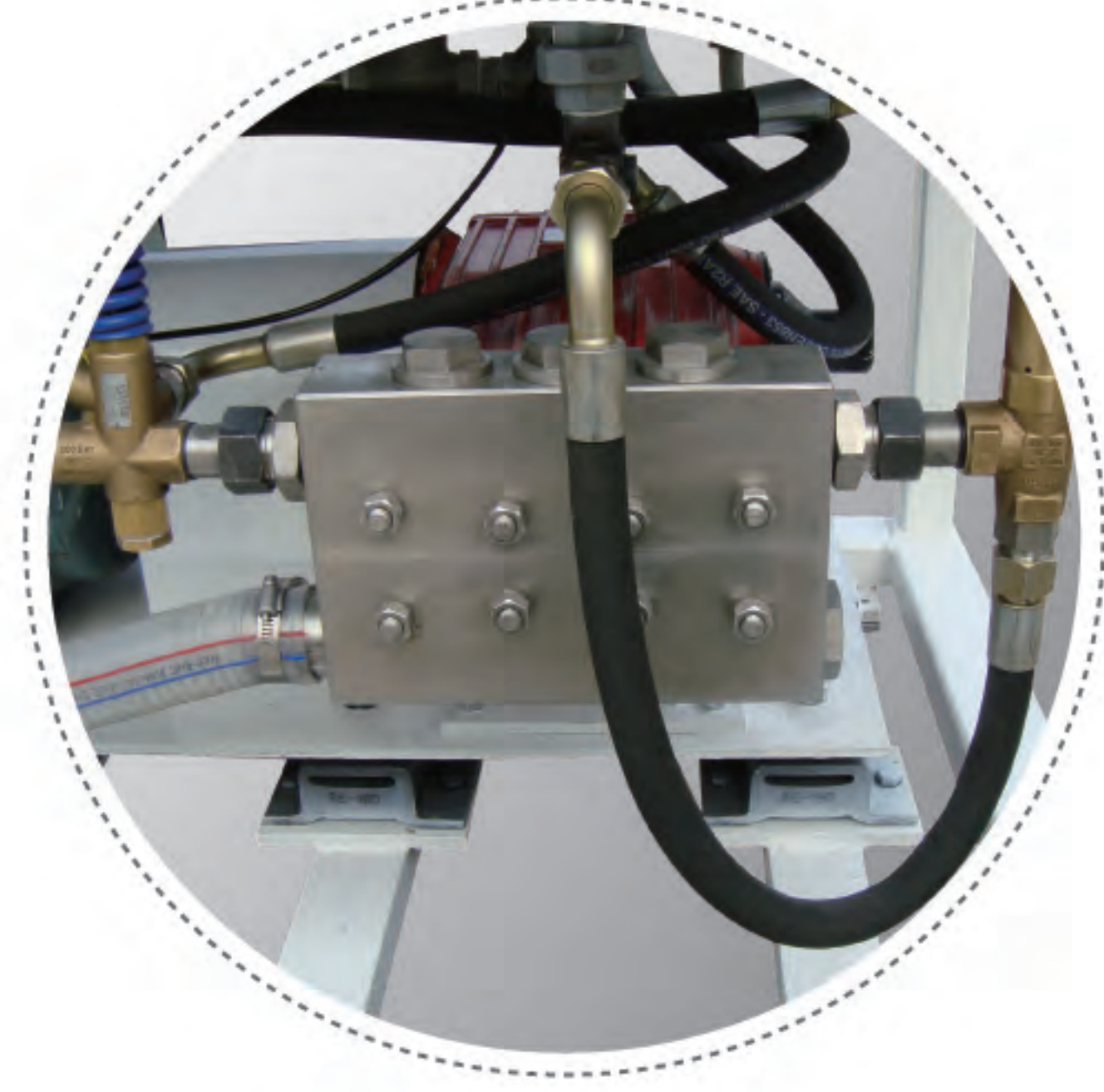

• 上重高压纯水试验装置
High-pressure pure water testing device

高压水系统 High-pressure water systems

- 流量可至60L/min
- 压力可至25MPa
- Flow up to 60L/min
- Pressure up to 25MPa

上海重型机器厂扩管涨型机液压系统 Hydraulic systems for pipe expanding machine

油箱容积：7000L
系统流量：2000L/min
系统压力：28MPa

Reservoir Capacity: 7000L
System Flow: 2000L/min
System Pressure: 28MPa

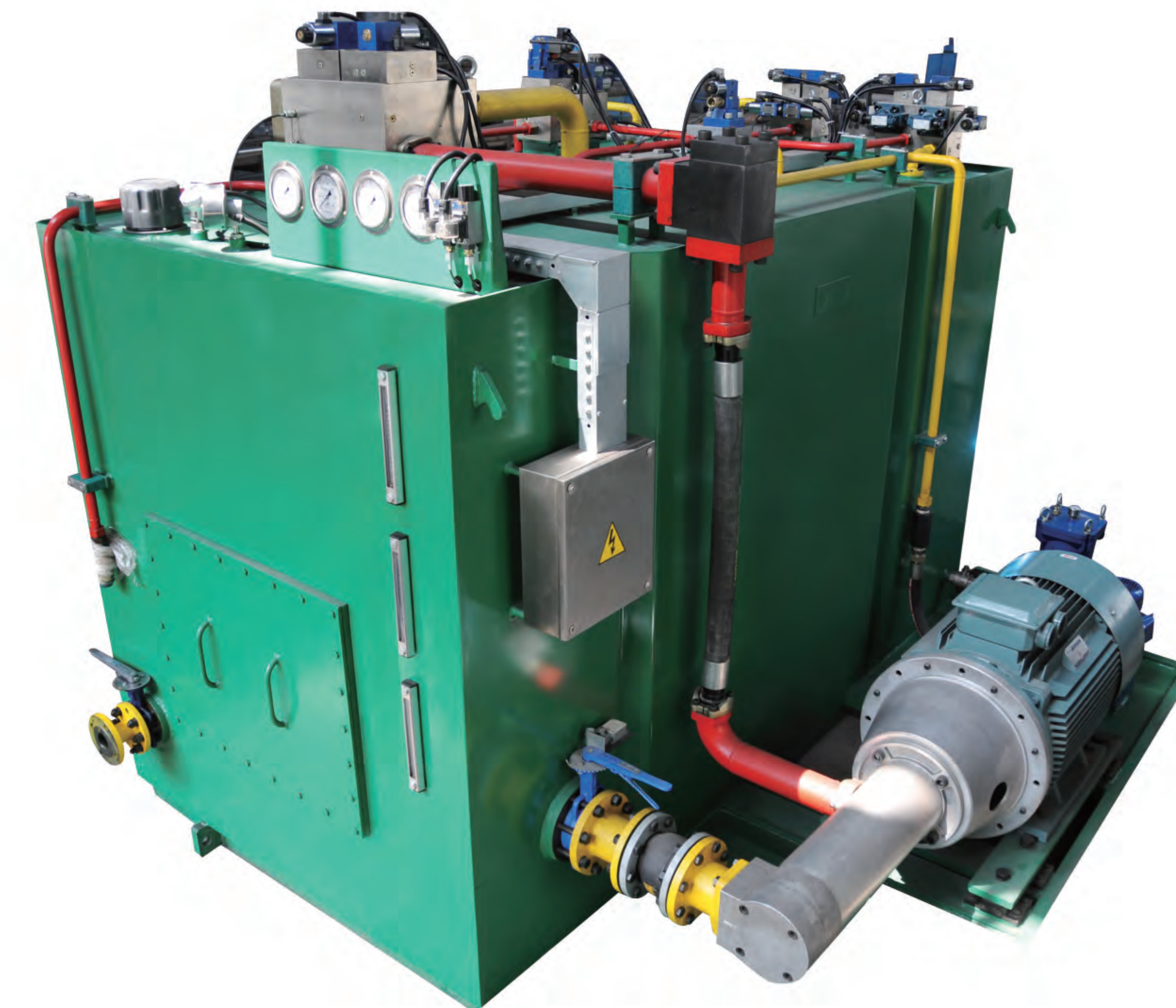



静音泵站 Silent HPU

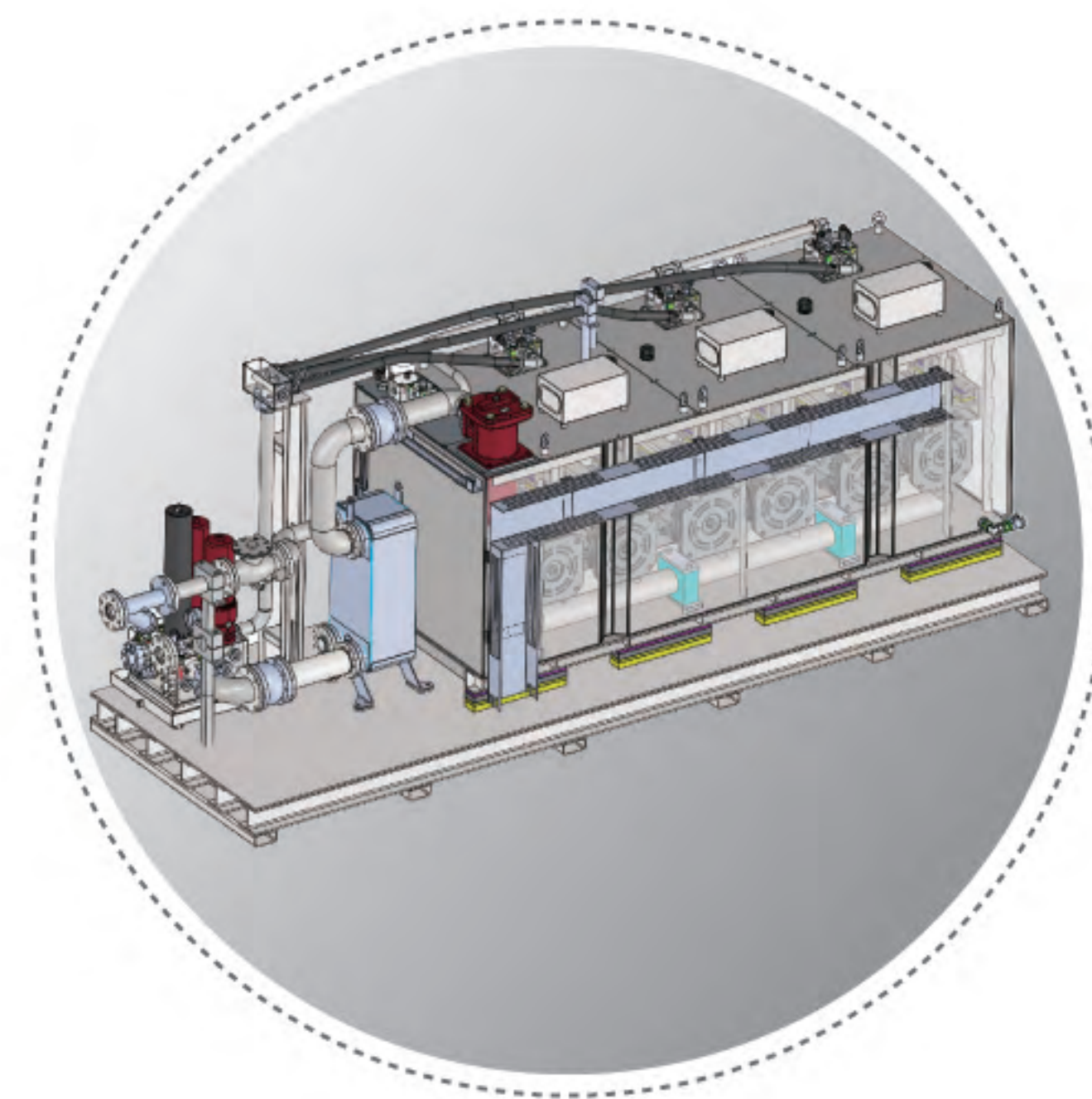

隧道盾构机液压站 Hydraulic systems for TBM

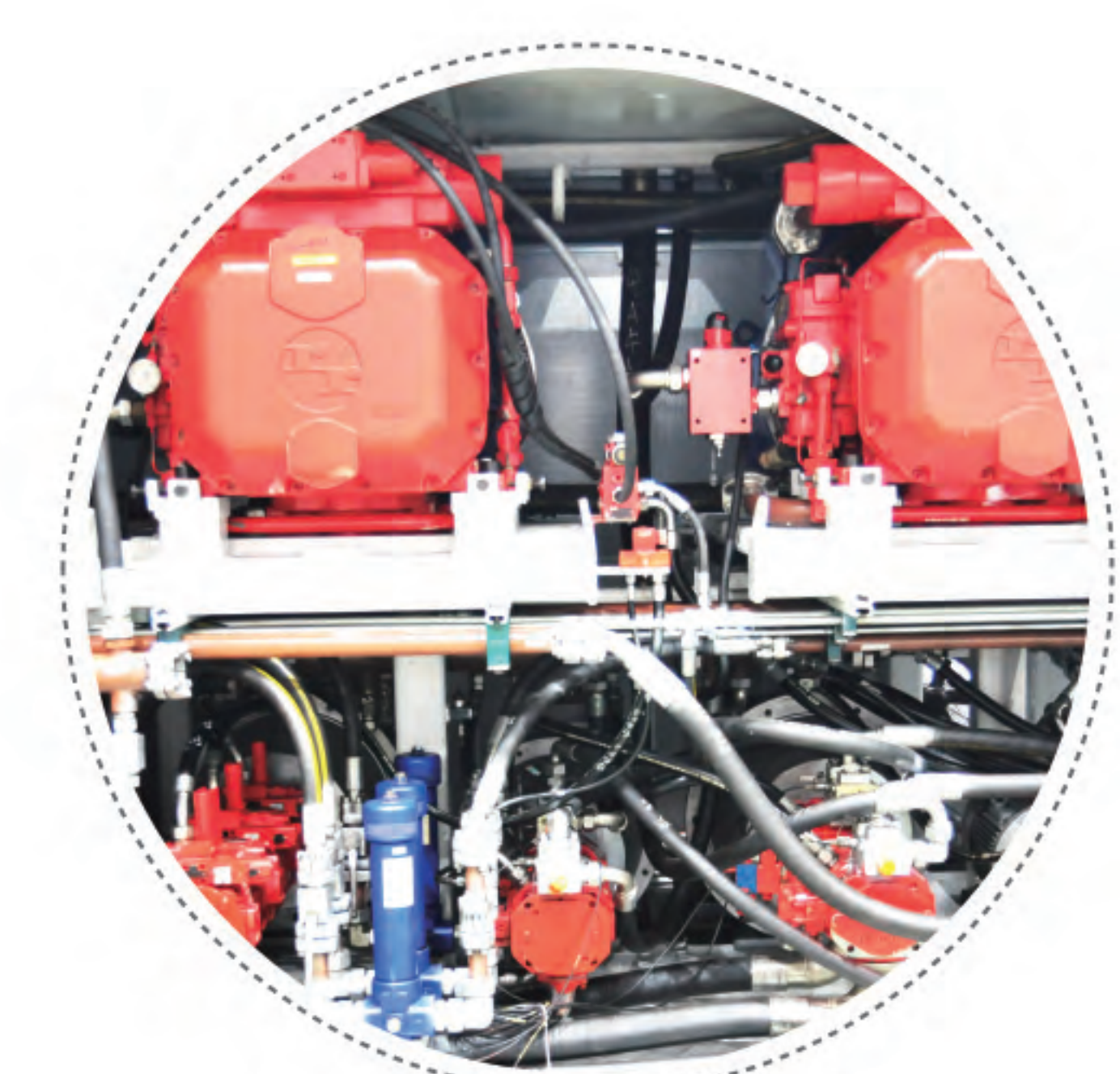
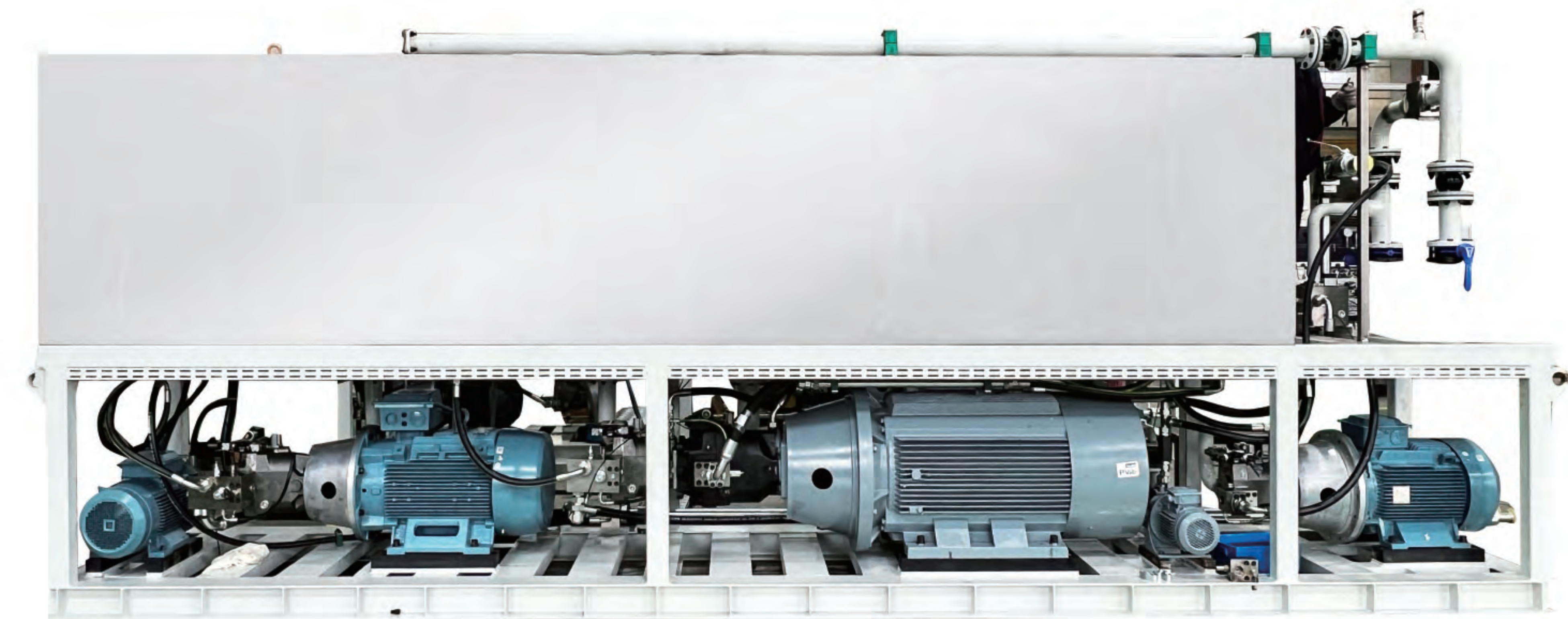

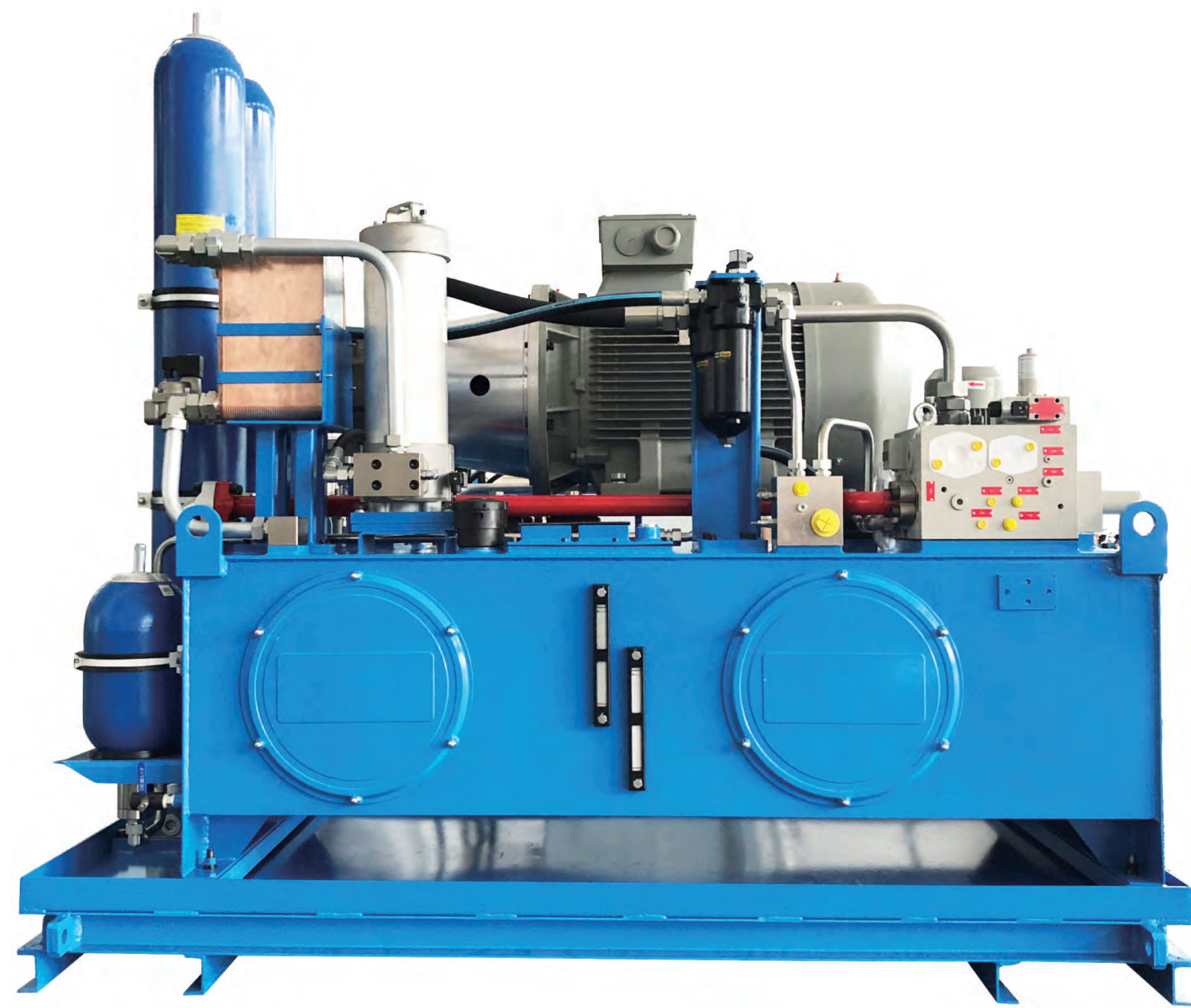
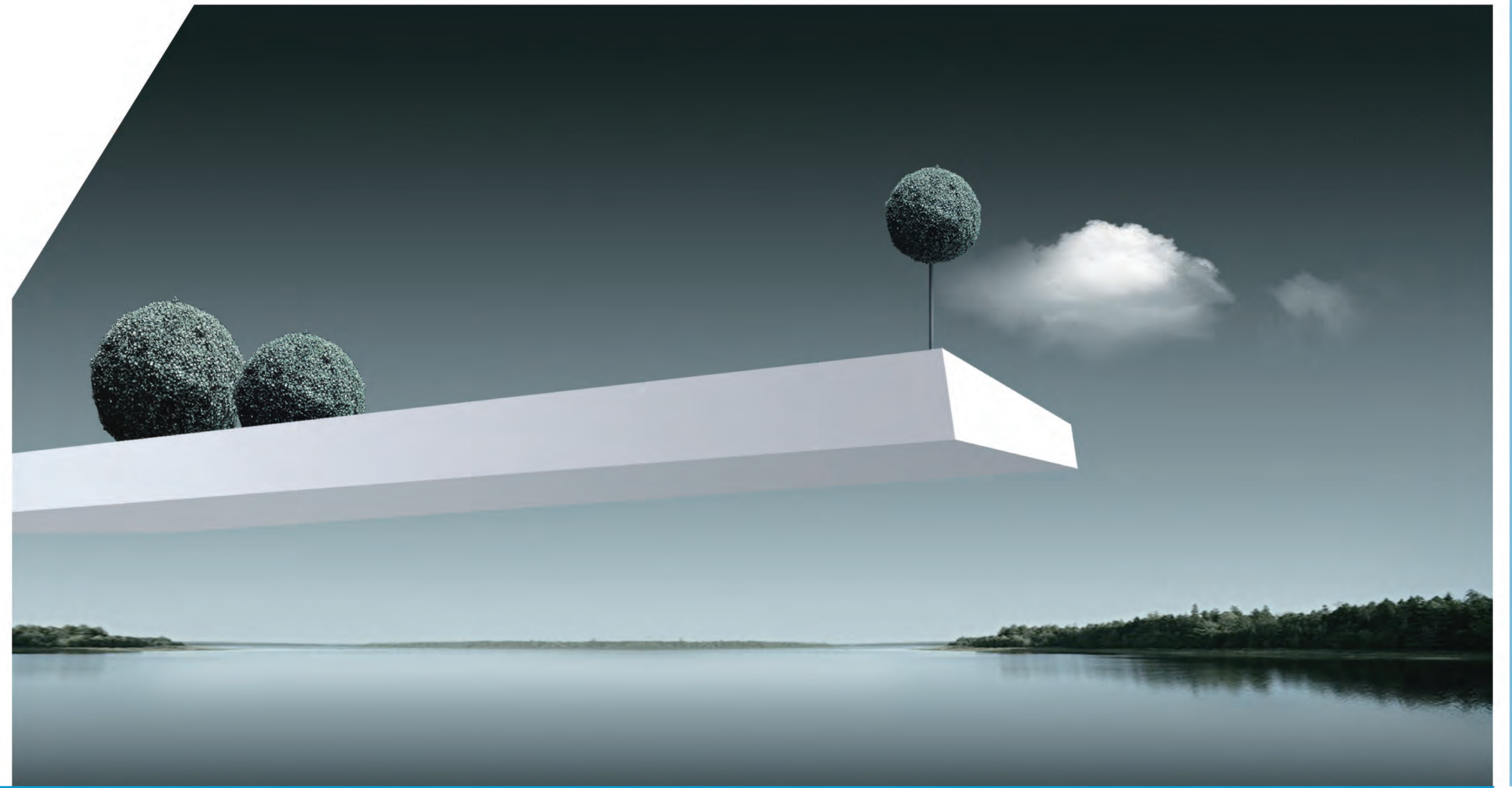
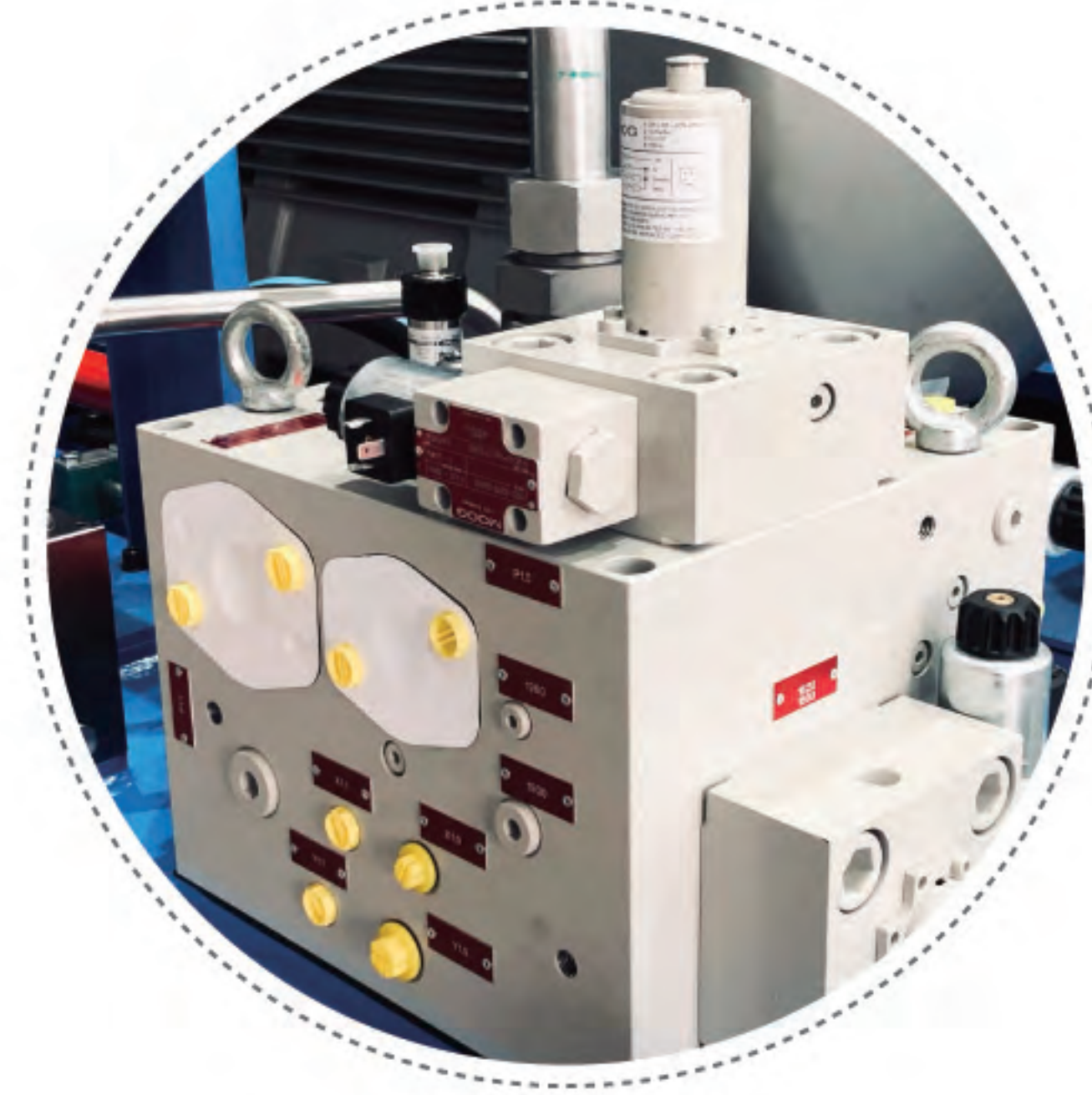
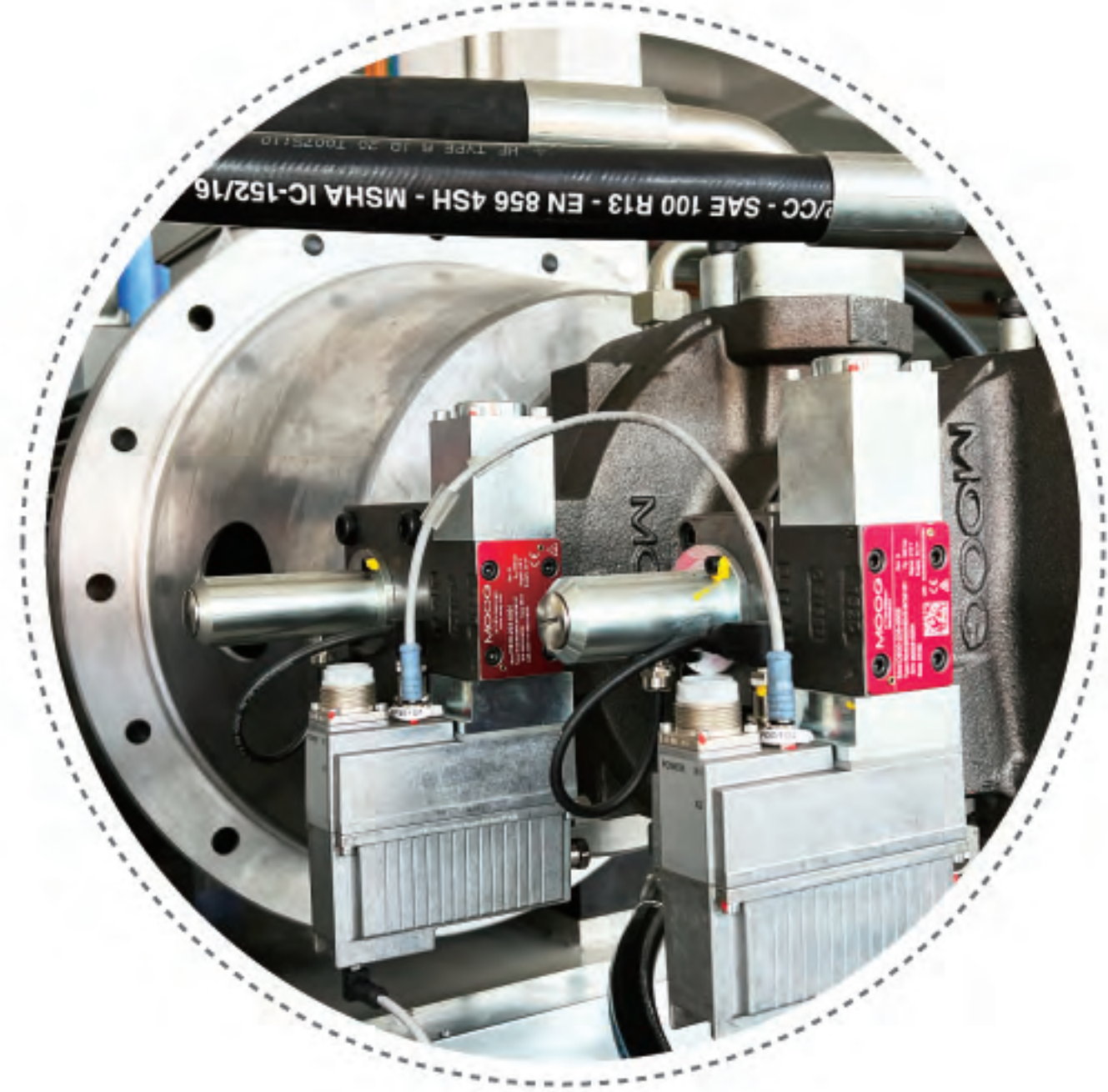

压机液压系统

Hydraulic systems for press machine

电子电路板层压机液压系统

Hydraulic system for circuit board laminator





• 水乙二醇铝轮毂压铸液压系统
Hydraulic system for water-glycol
aluminum hubs casting

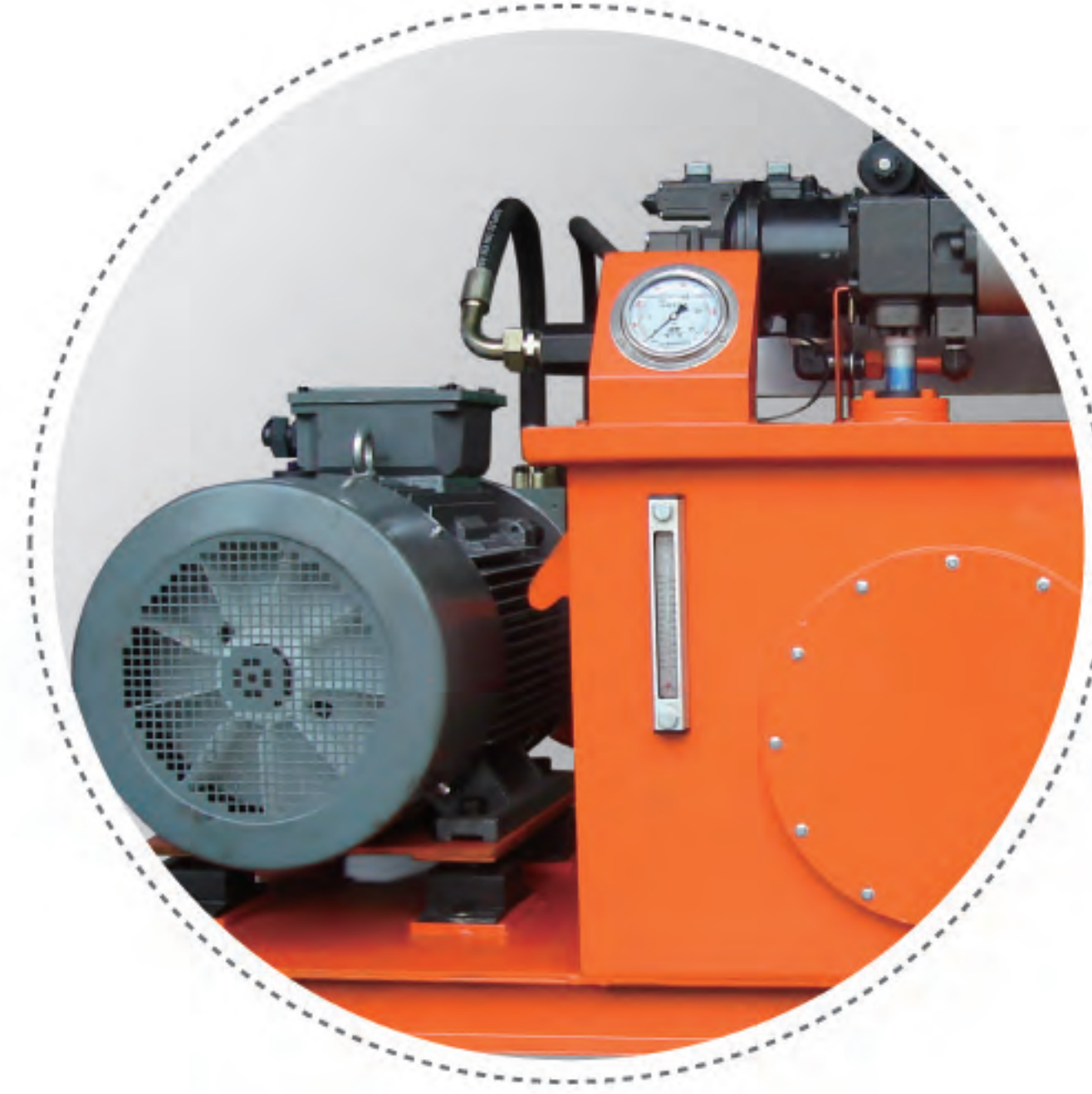

• 指示仪表特写
Indicating instrument

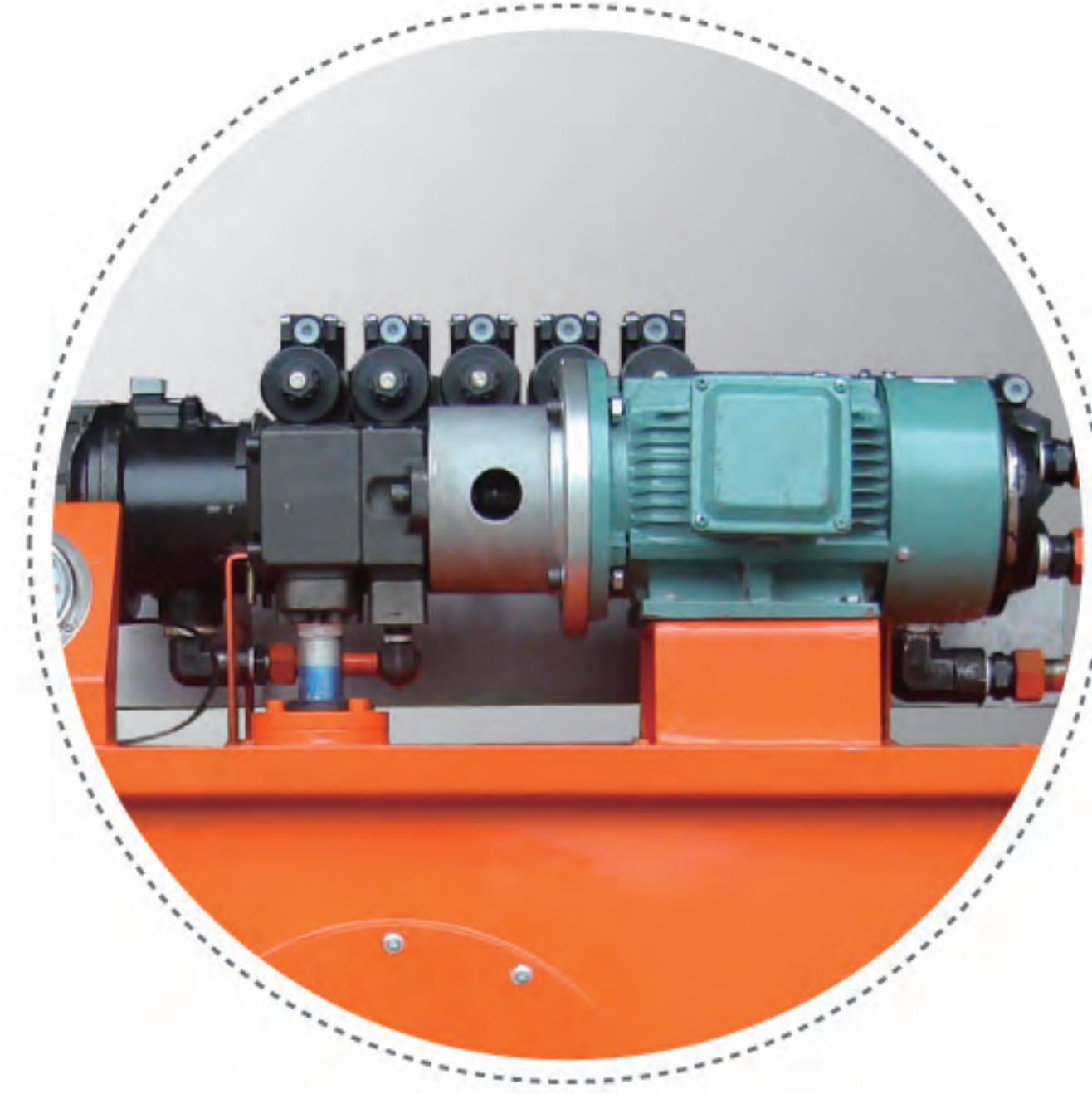

• 循环泵组及阀组
Circulating pump group
and valve block



汽车行业液压系统 Hydraulic systems for automotive industry

- 发动机试验设备配润滑及冷却系统
- 齿轮箱试验设备配润滑及冷却系统
- 变速箱试验设备配润滑及冷却系统
- 汽车铝轮毂压铸设备液压系统
- 汽车发动机铝铸件加工液压系统
- 汽车减震器压合设备液压系统



• 系统局部特写
Partial features of the
system



• 系统局部特写
Partial features of the
system

- Lubricating and cooling systems for engine testing equipment
- Lubricating and cooling systems for gearbox testing equipment
- Lubrication and cooling systems for transmission case testing equipment
- Hydraulic systems for die-casting equipment of automotive aluminum hubs
- Hydraulic systems for aluminum castings processing of automobile engine
- Hydraulic systems for the pressing machine of automobile absorber



• 汽车喷漆生产线液压泵站
Hydraulic pump station for the production
line for automobile spray painting

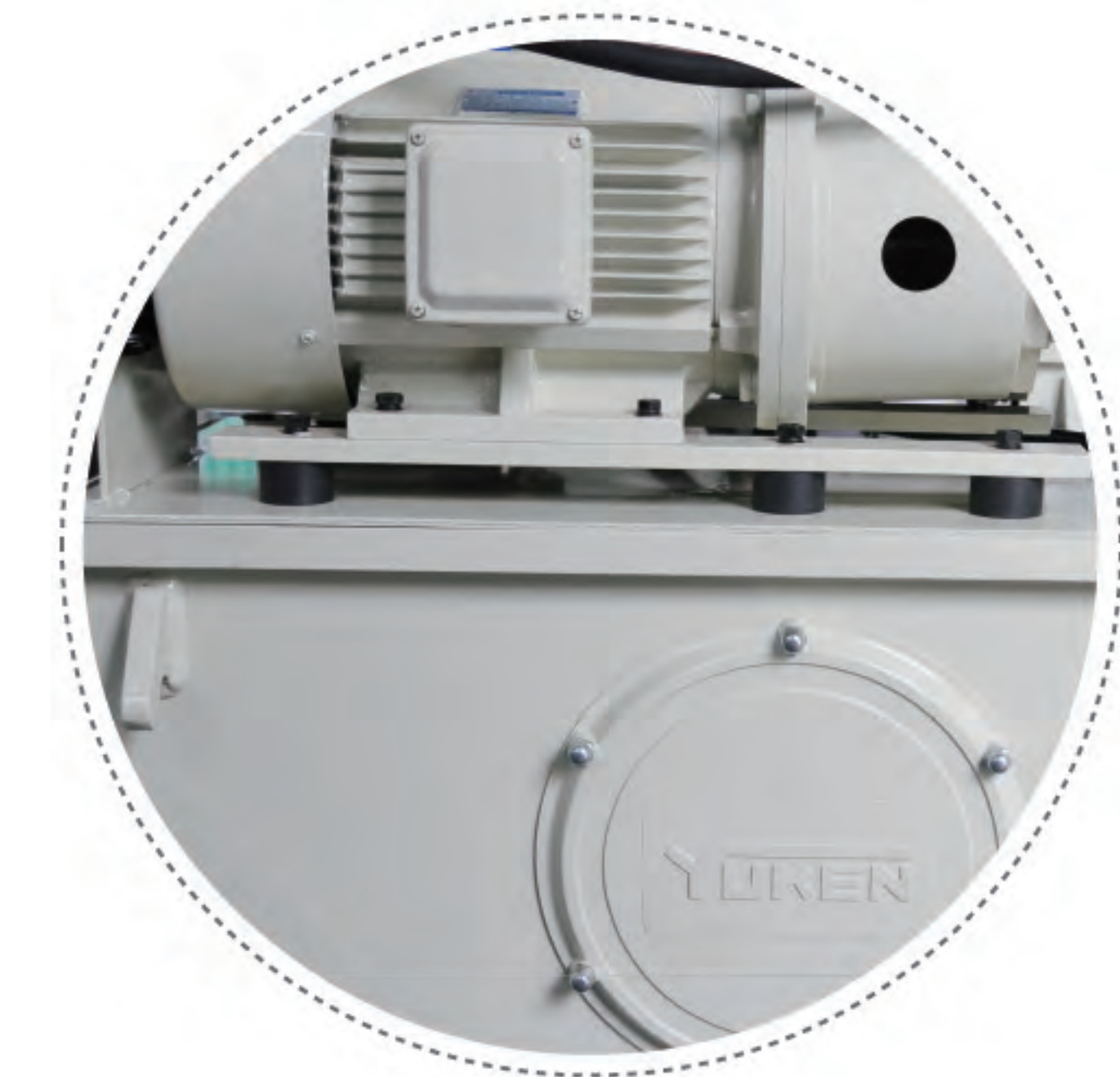

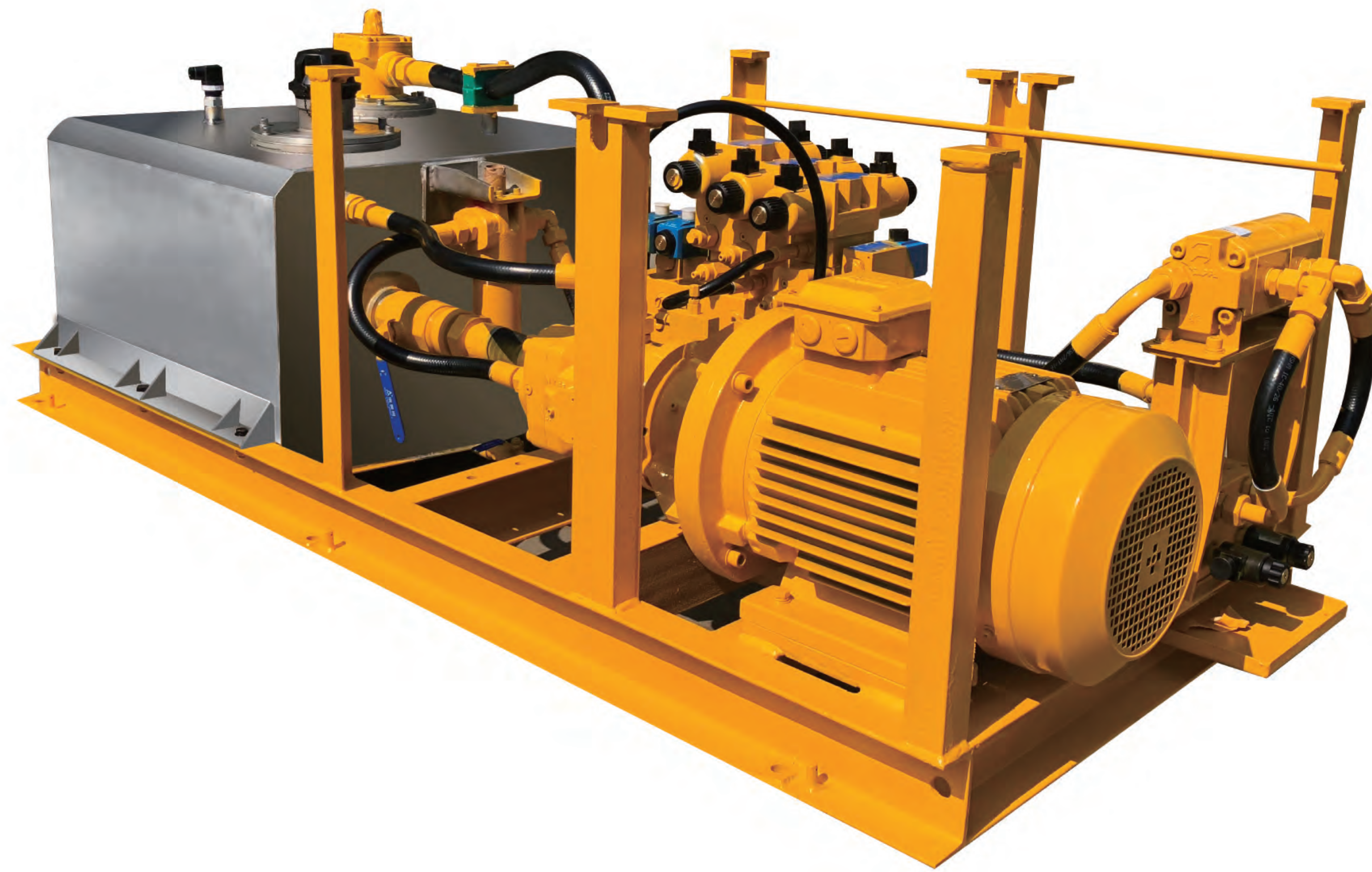

港口机械液压系统

Hydraulic systems for Port machinery

- 克令吊液压系统
- 龙门吊液压系统
- 堆料机液压系统
- 抓斗液压系统
- 集装箱吊具液压系统
- 卸船机液压系统
- Hydraulic systems for ship crane
- Hydraulic systems for gantry crane
- Hydraulic systems for Stacker
- Hydraulic systems for Grab
- Hydraulic systems for Container spreader
- Hydraulic system for ship unloaders

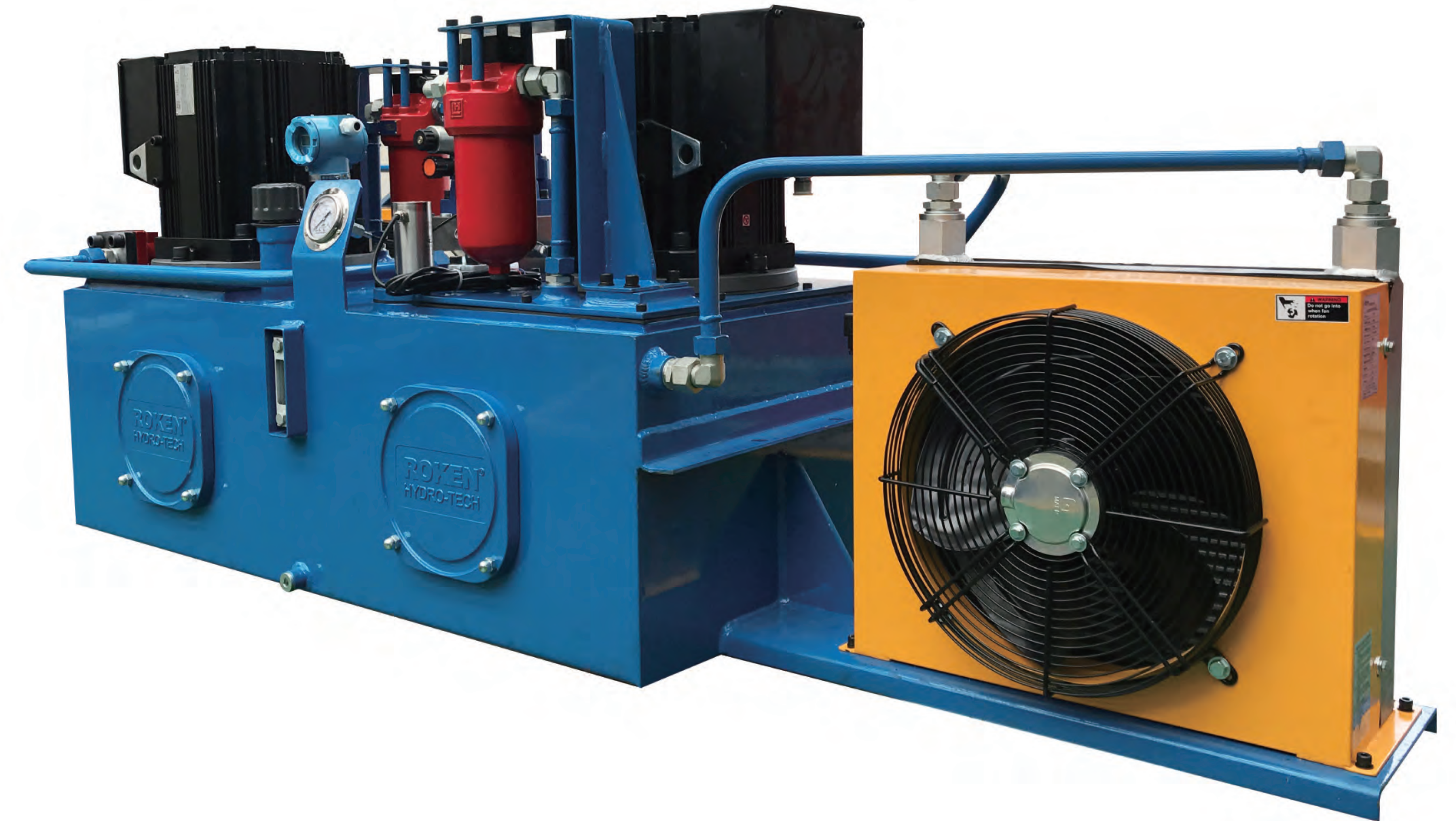

游乐设备液压系统

Hydraulic systems for Amusement equipment

- 流量可至60L/min
- 压力可至25MPa
- Flow up to 60L/min
- Pressure up to 25MPa

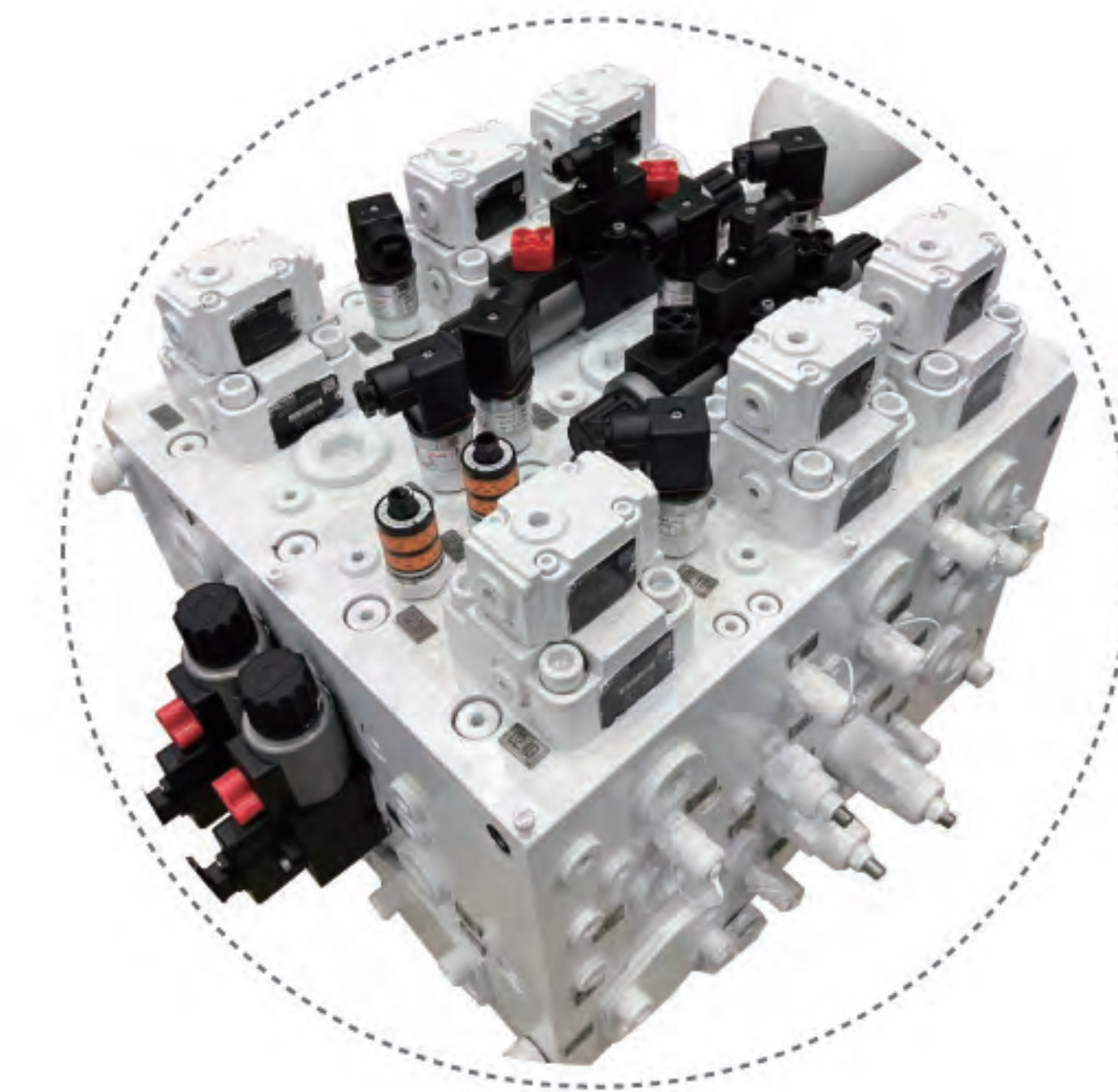

船舶液压站/可持船级社认证

Hydraulic stations for Shipping industry / Can be certified by classification society

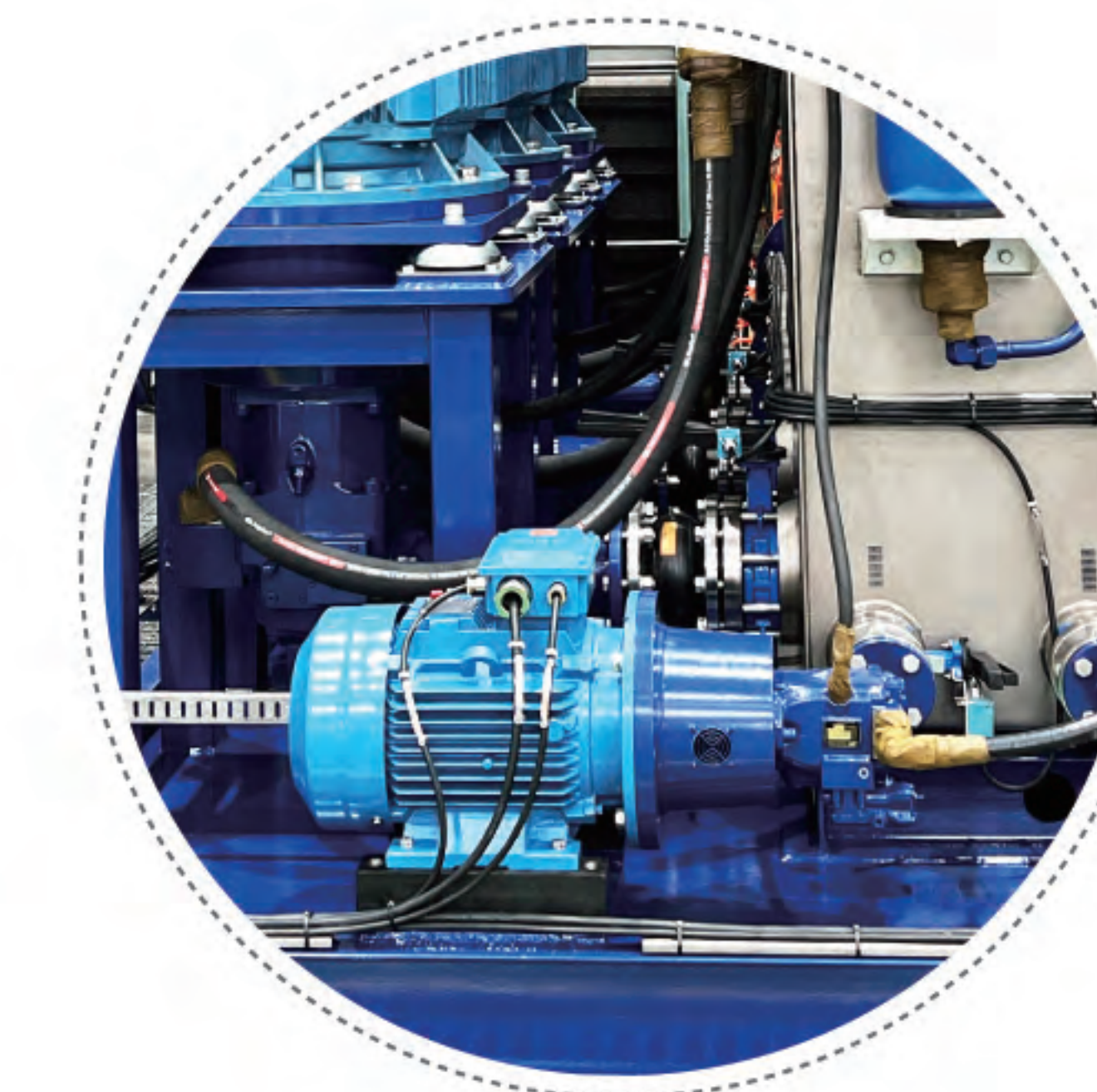
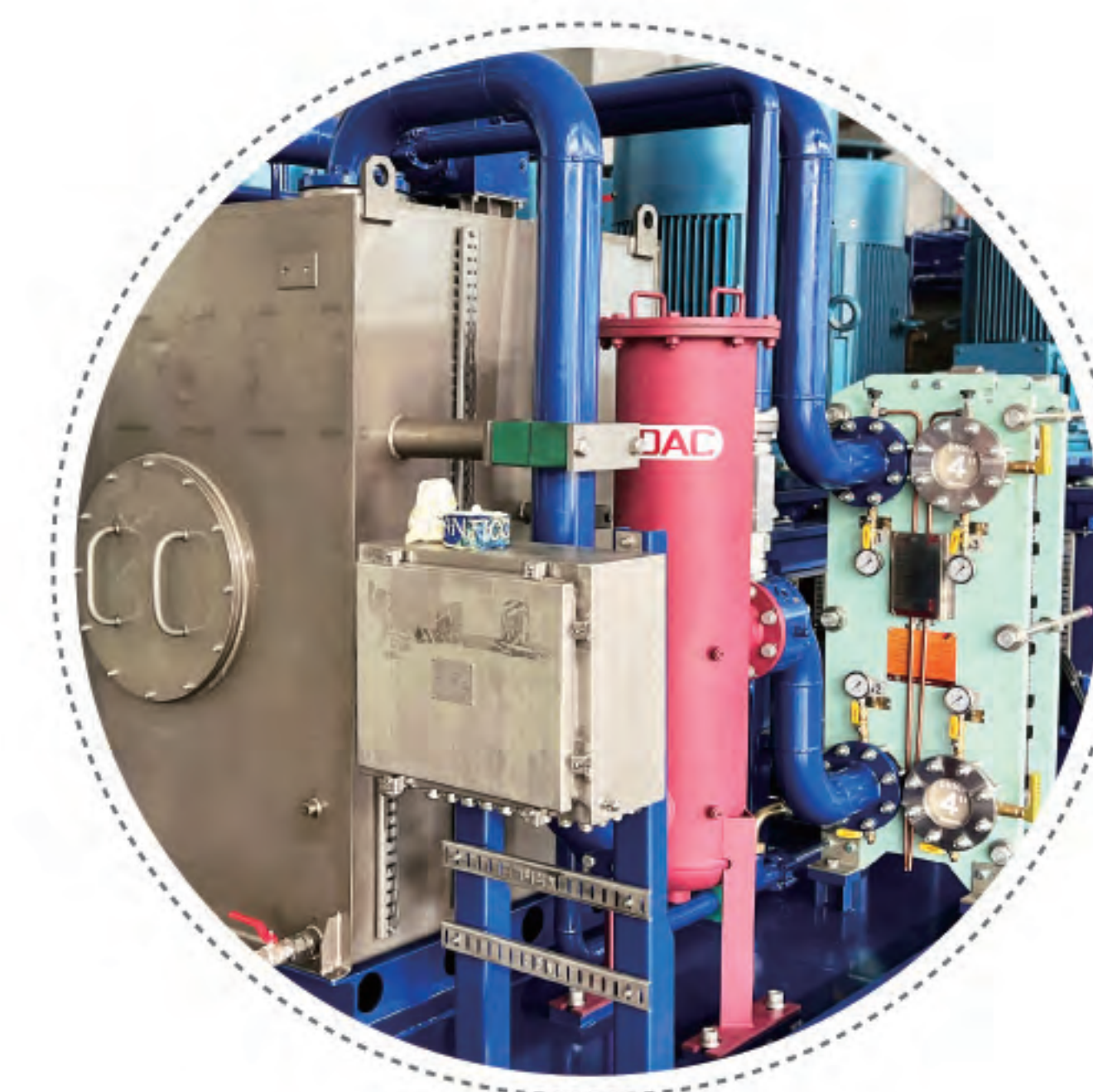
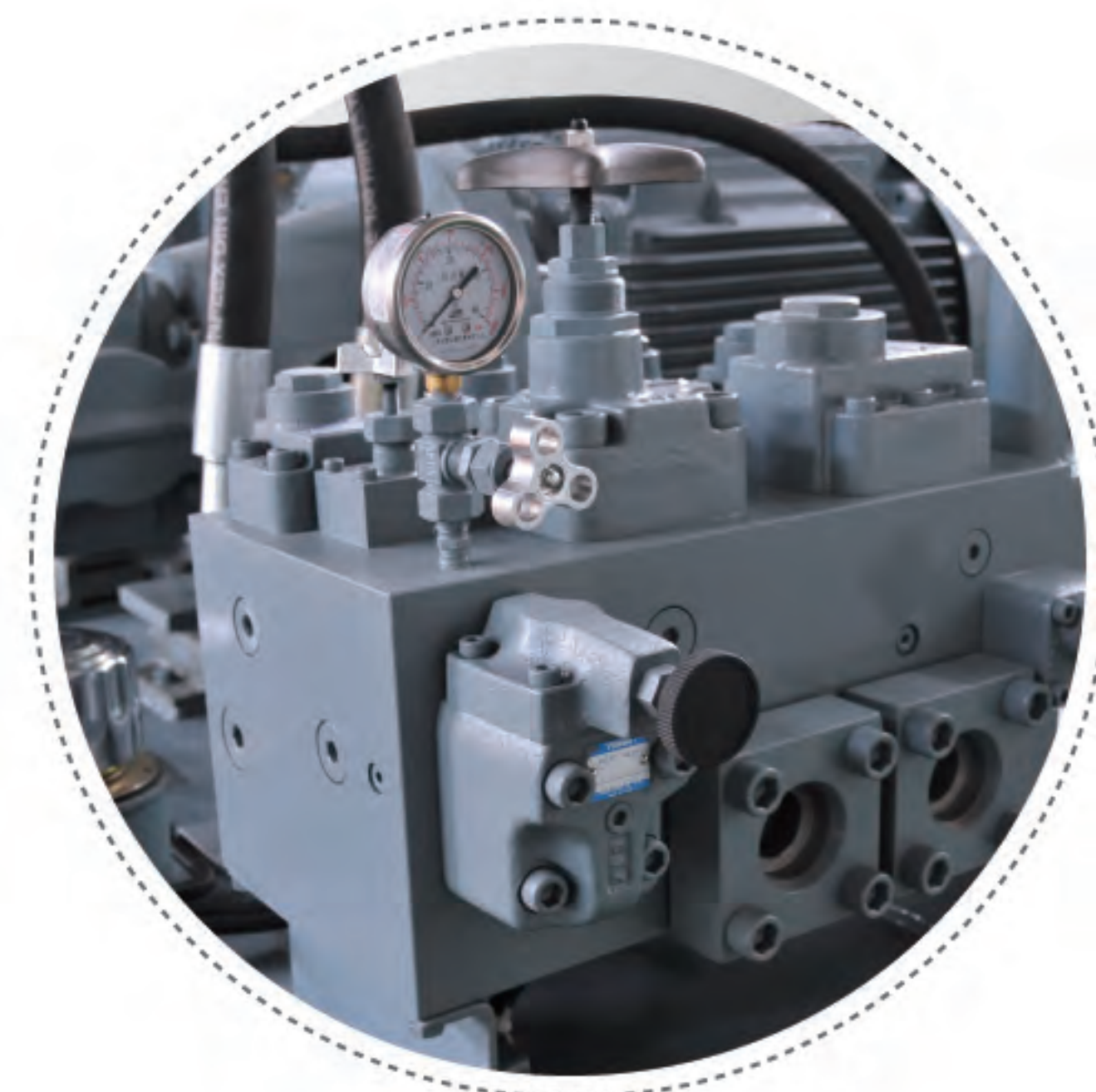

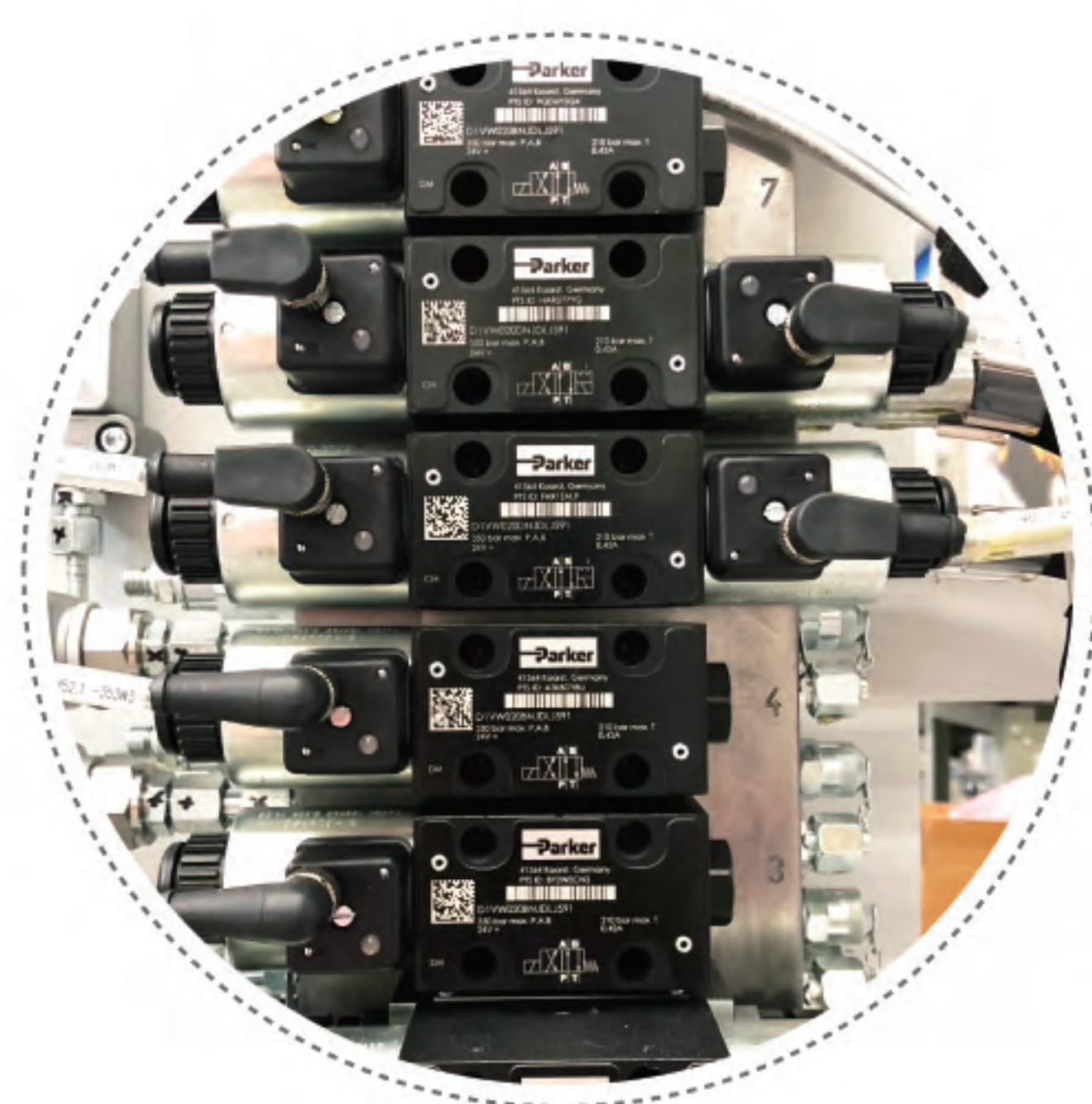

组合机床液压站

Hydraulic systems for Combined machine tools



轮胎硫化机液压站

Hydraulic systems for Tyre vulcanizer

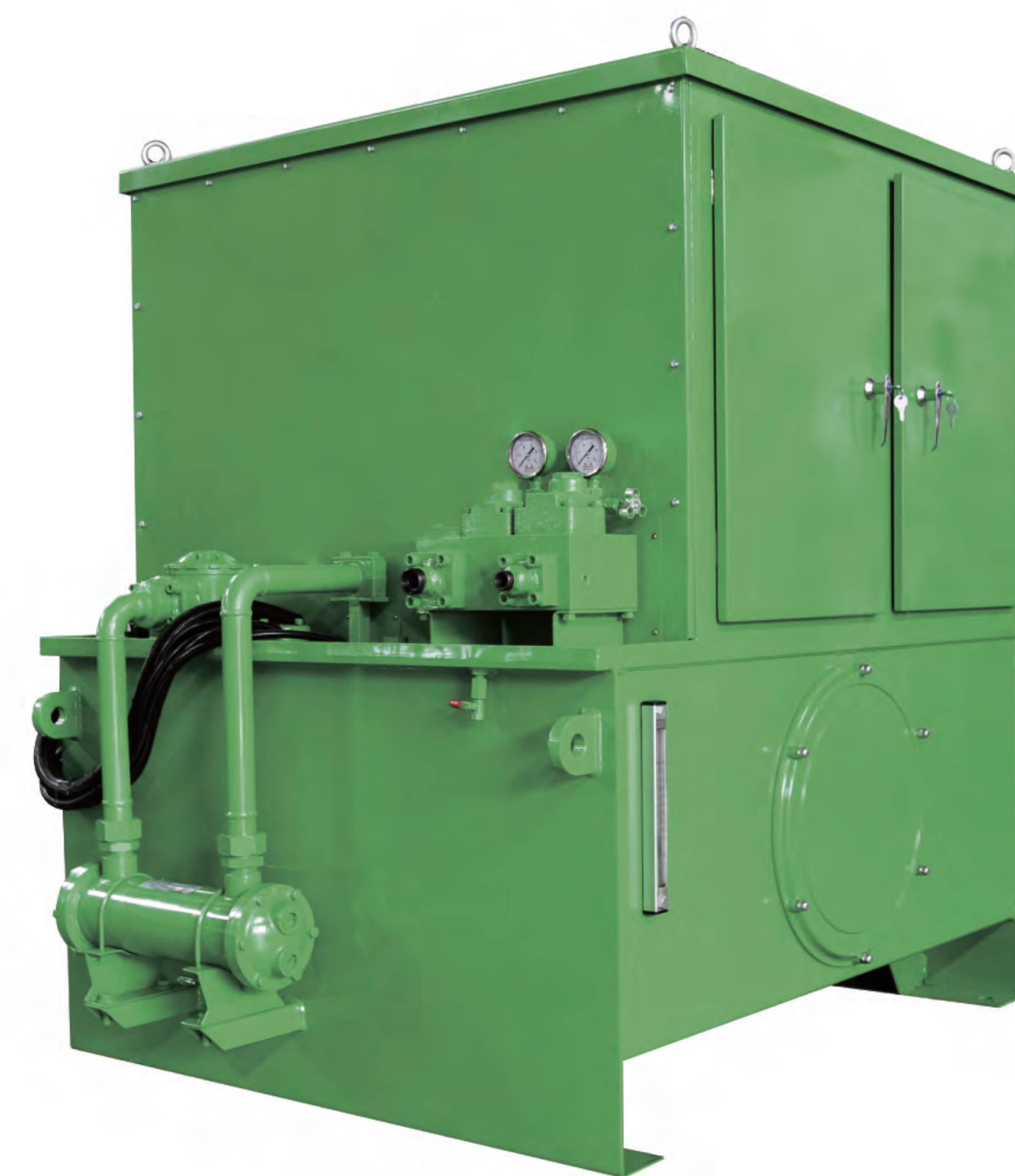



冶金液压系统

Hydraulic systems for metallurgical industry

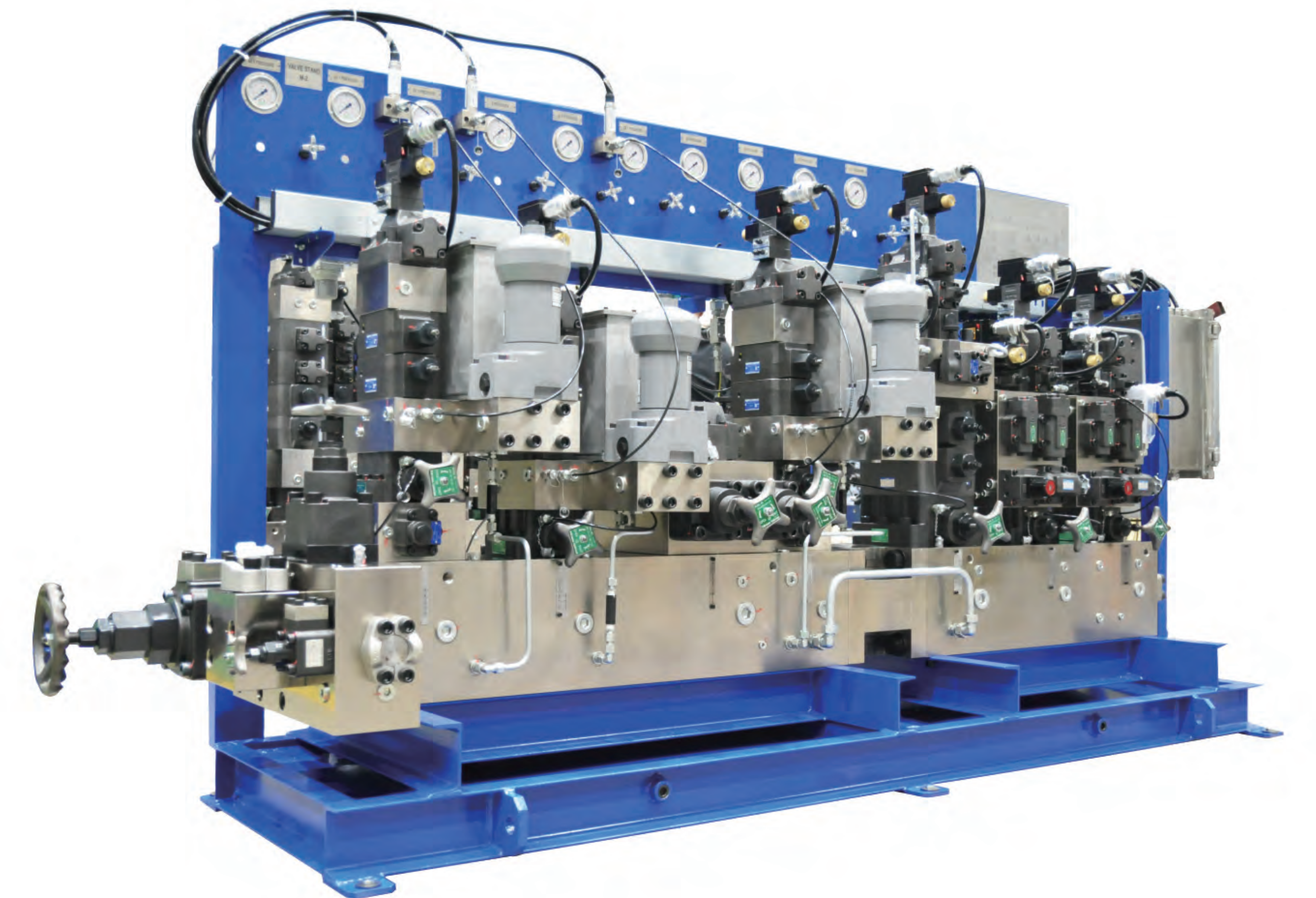
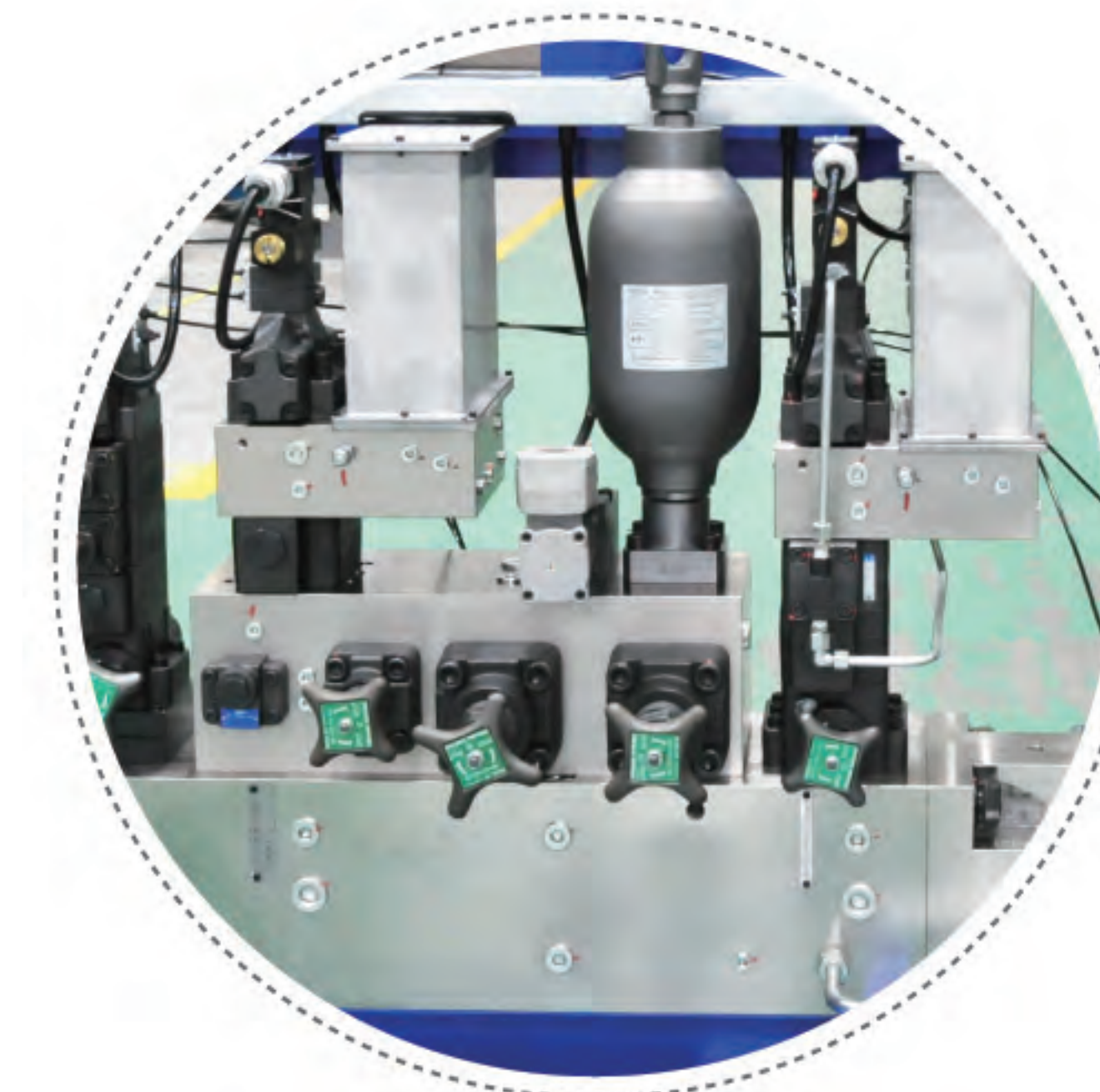
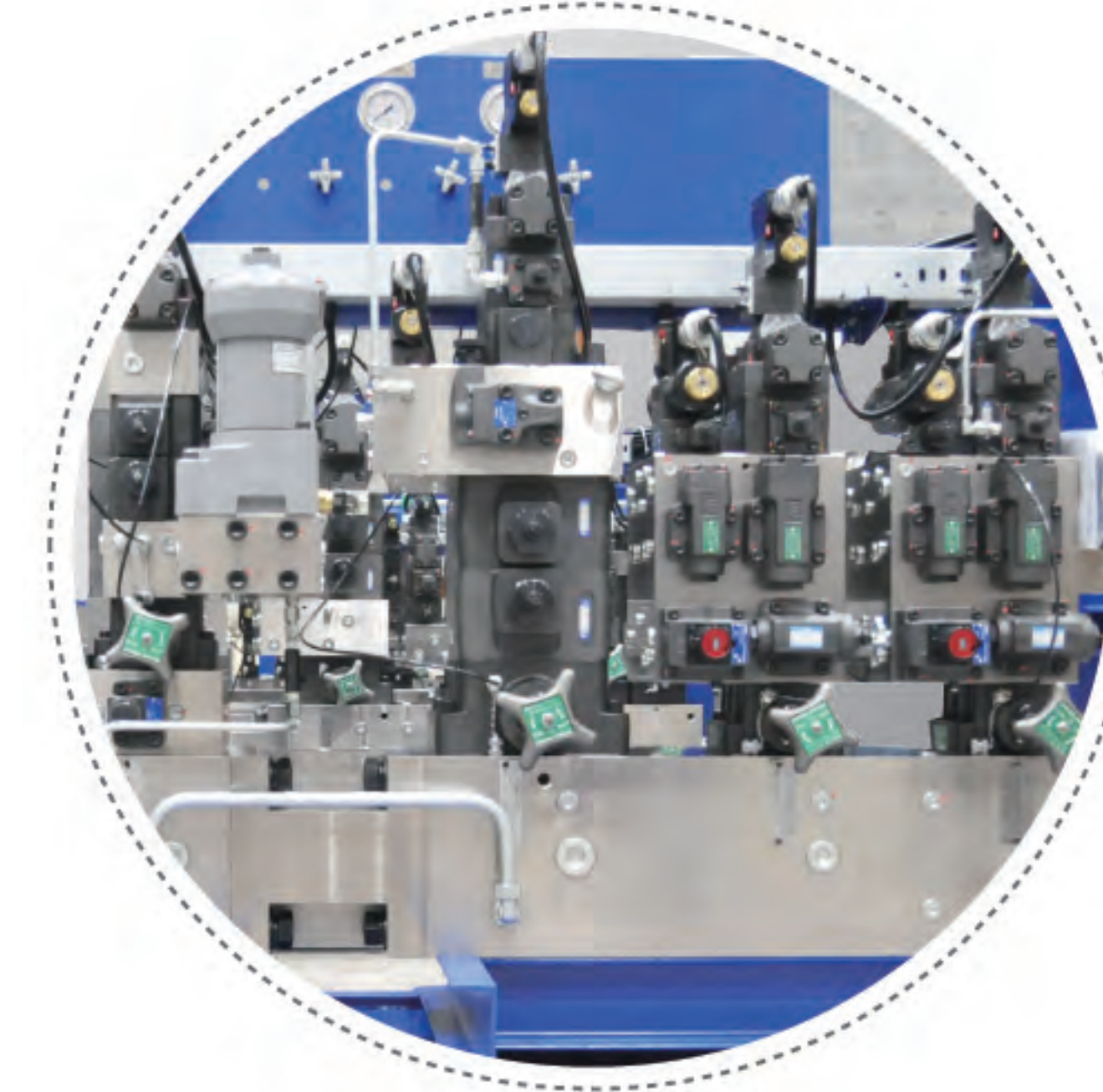
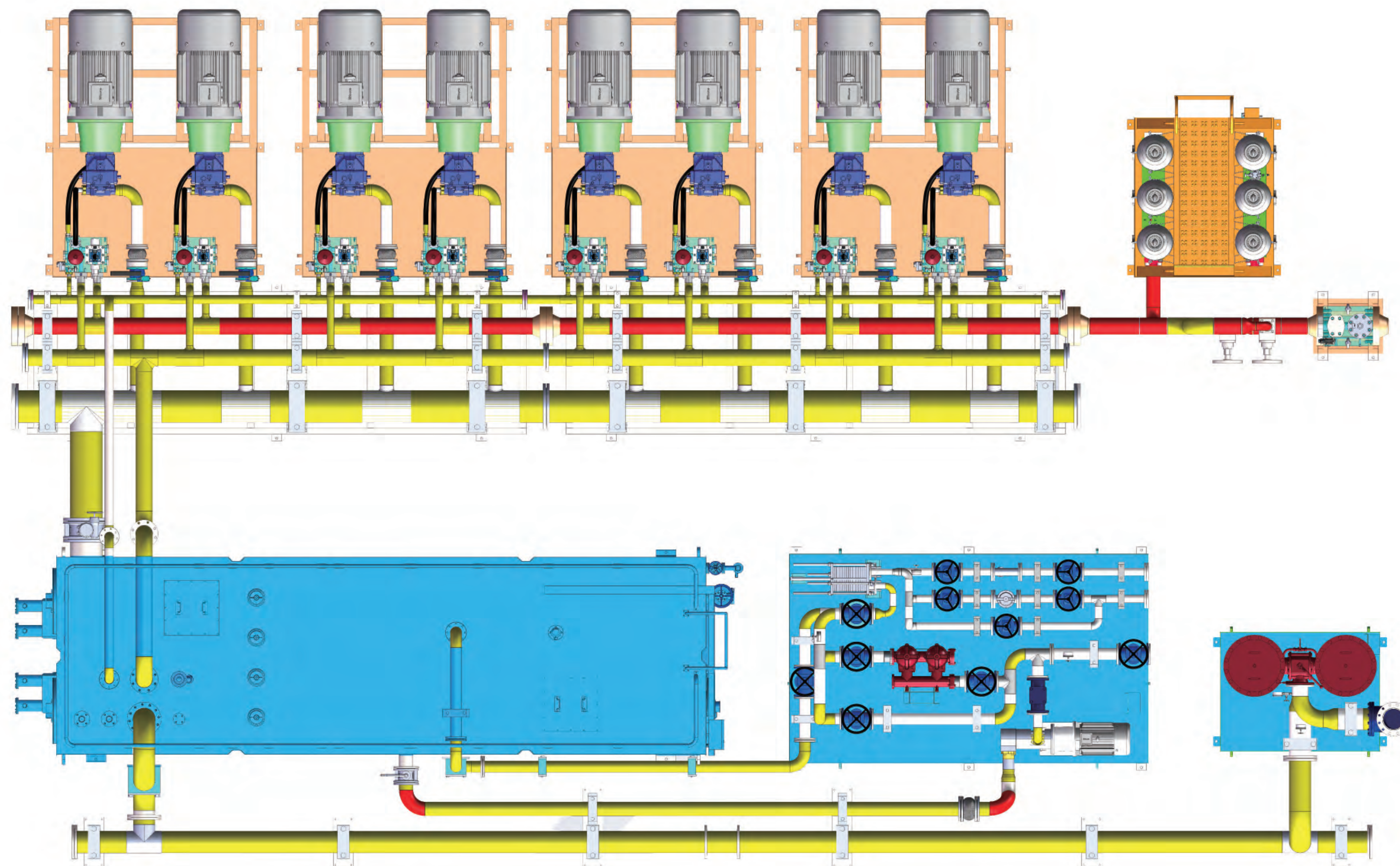



环卫设备及配套液压系统

Sanitation machinery and Hydraulic systems

- 自主研发与制造移动式固废压缩站
- 固废中转站配套液压系统
- 垃圾焚烧炉成套液压系统
- Design and manufacture of mobile solid waste compressors
- Hydraulic systems for solid waste compressors
- Hydraulic systems for solid waste incinerators

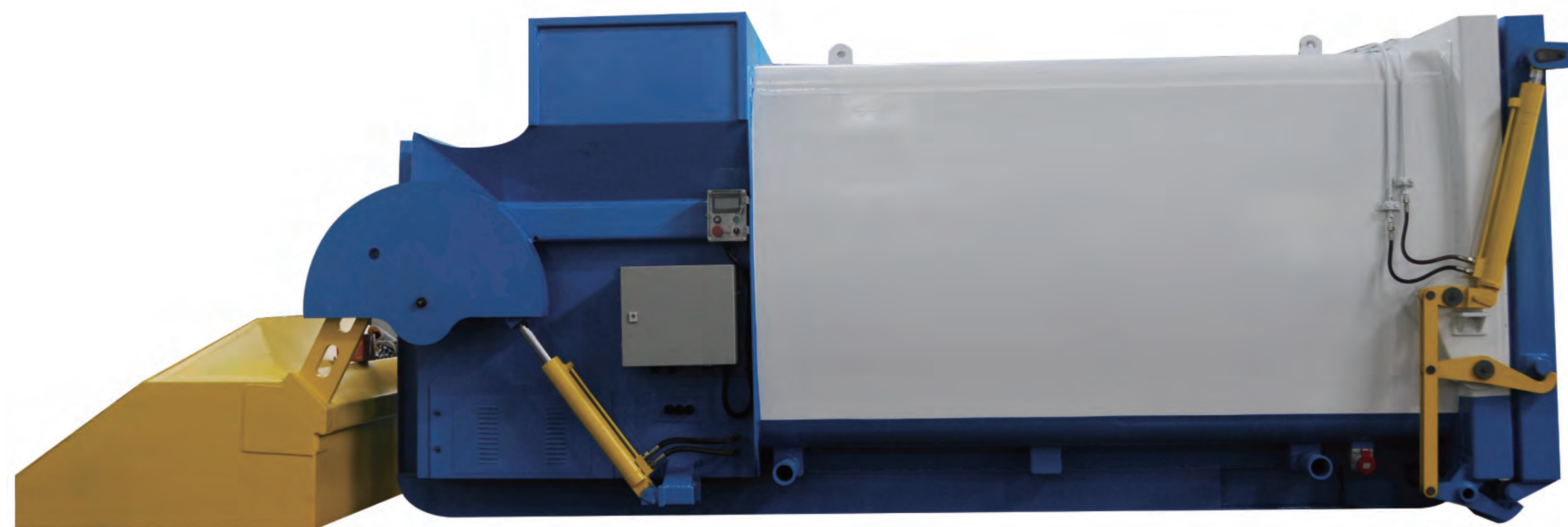
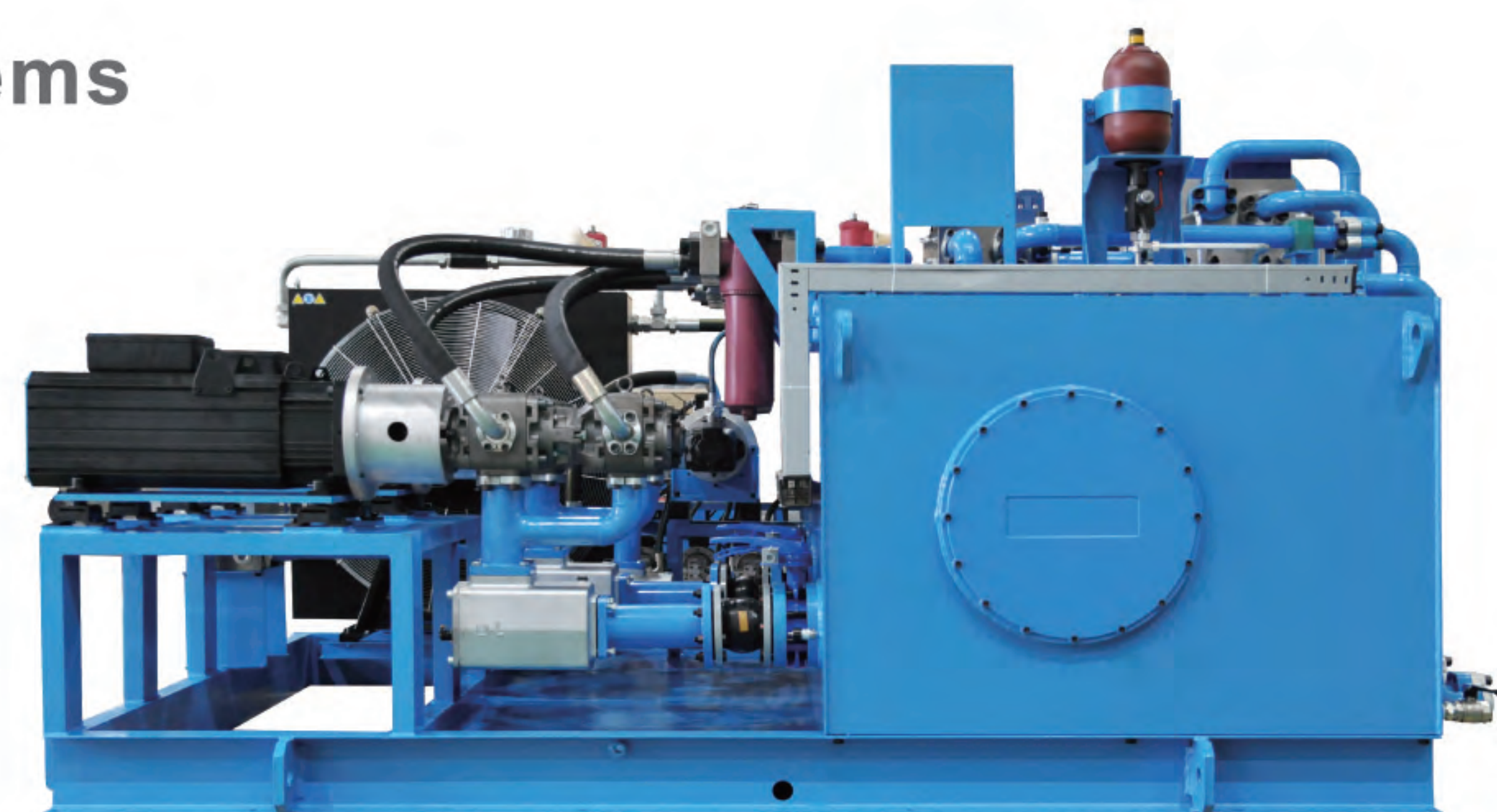

石油机械行业液压系统

Hydraulic systems for Petroleum machinery industry

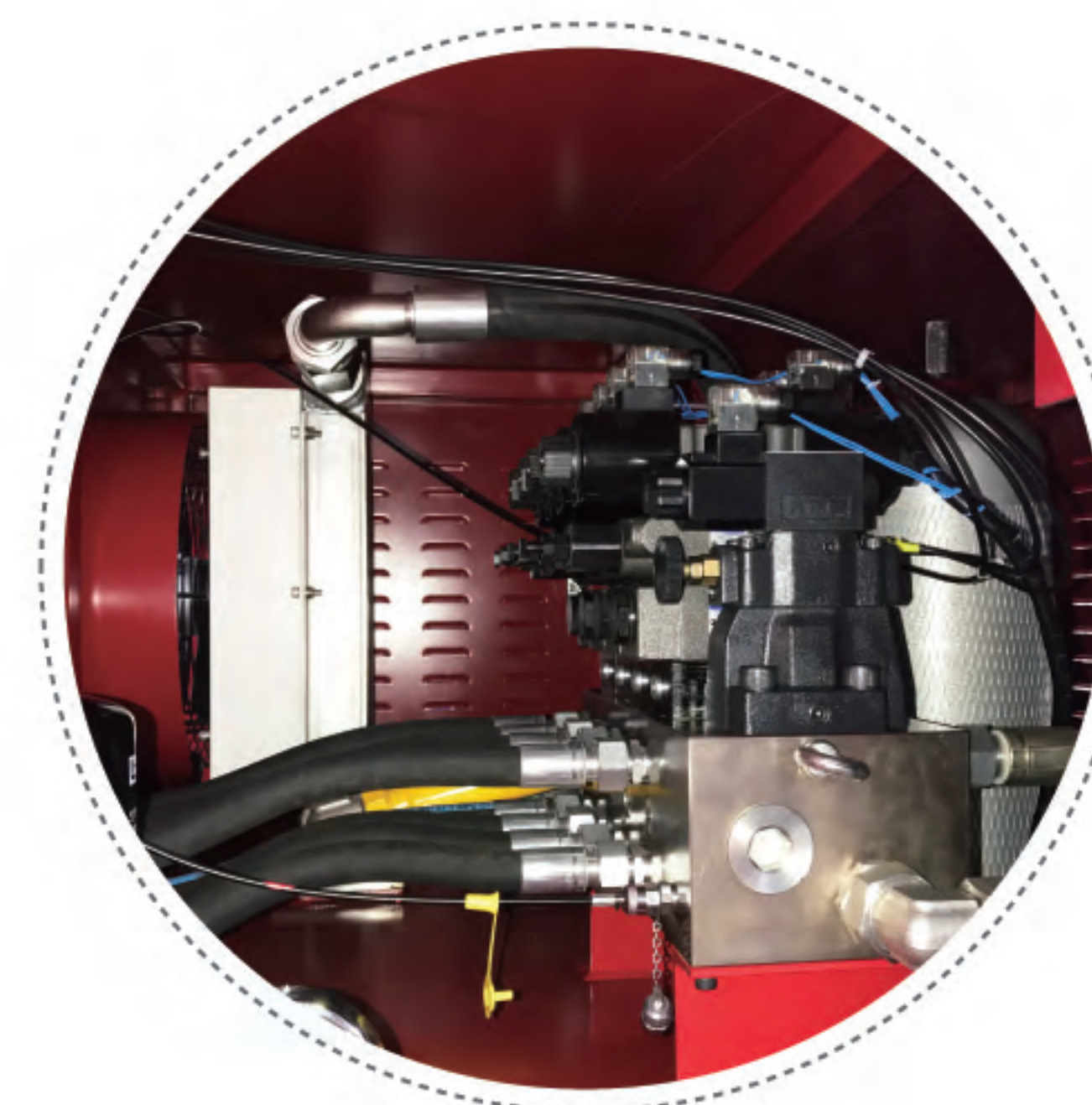



● 系统局部特写
Partial features of the system

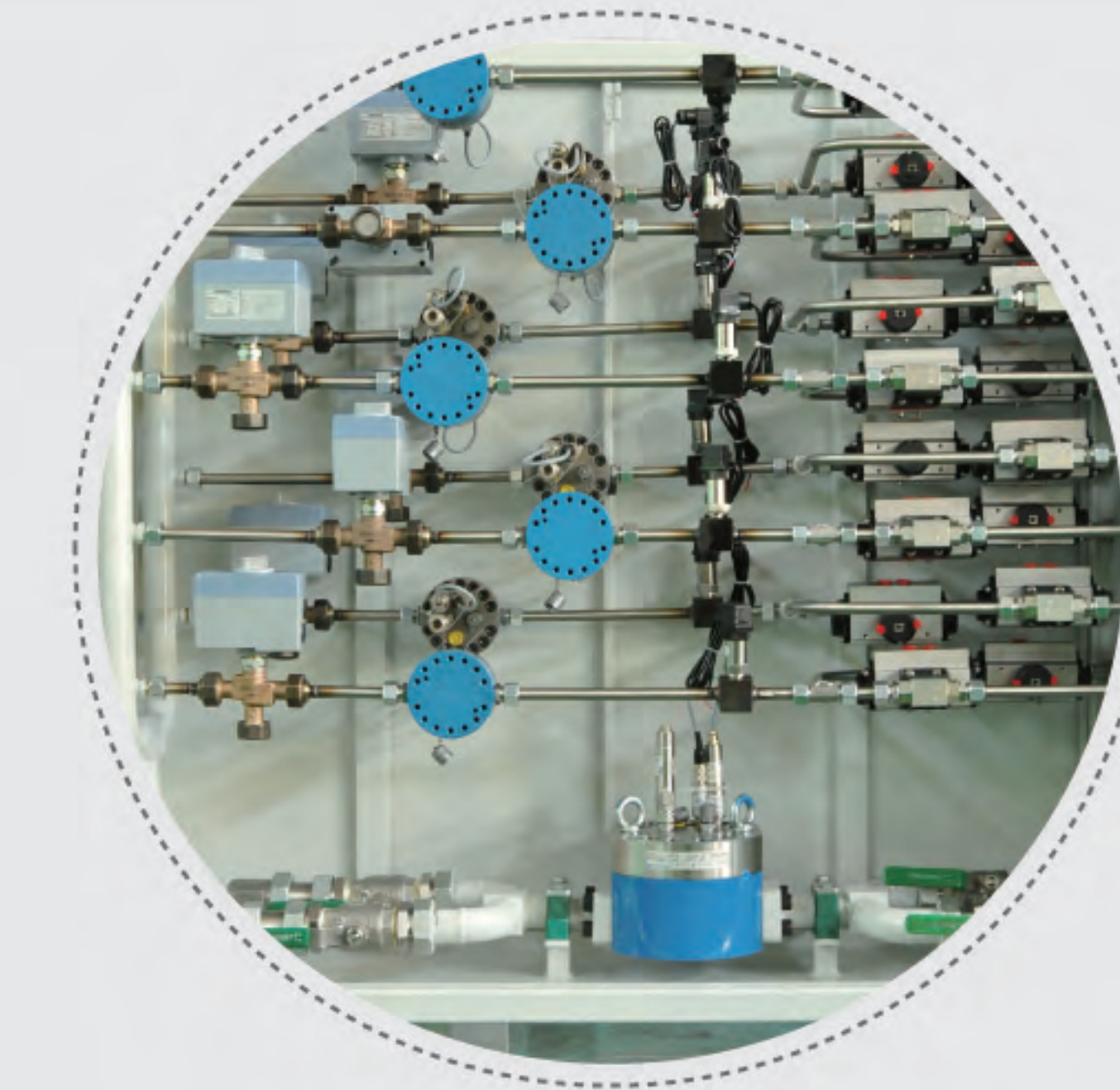

● 系统局部特写
Partial features of the system

英格索兰液压测试系统

Hydraulic testing systems for INGERSOLL RAND

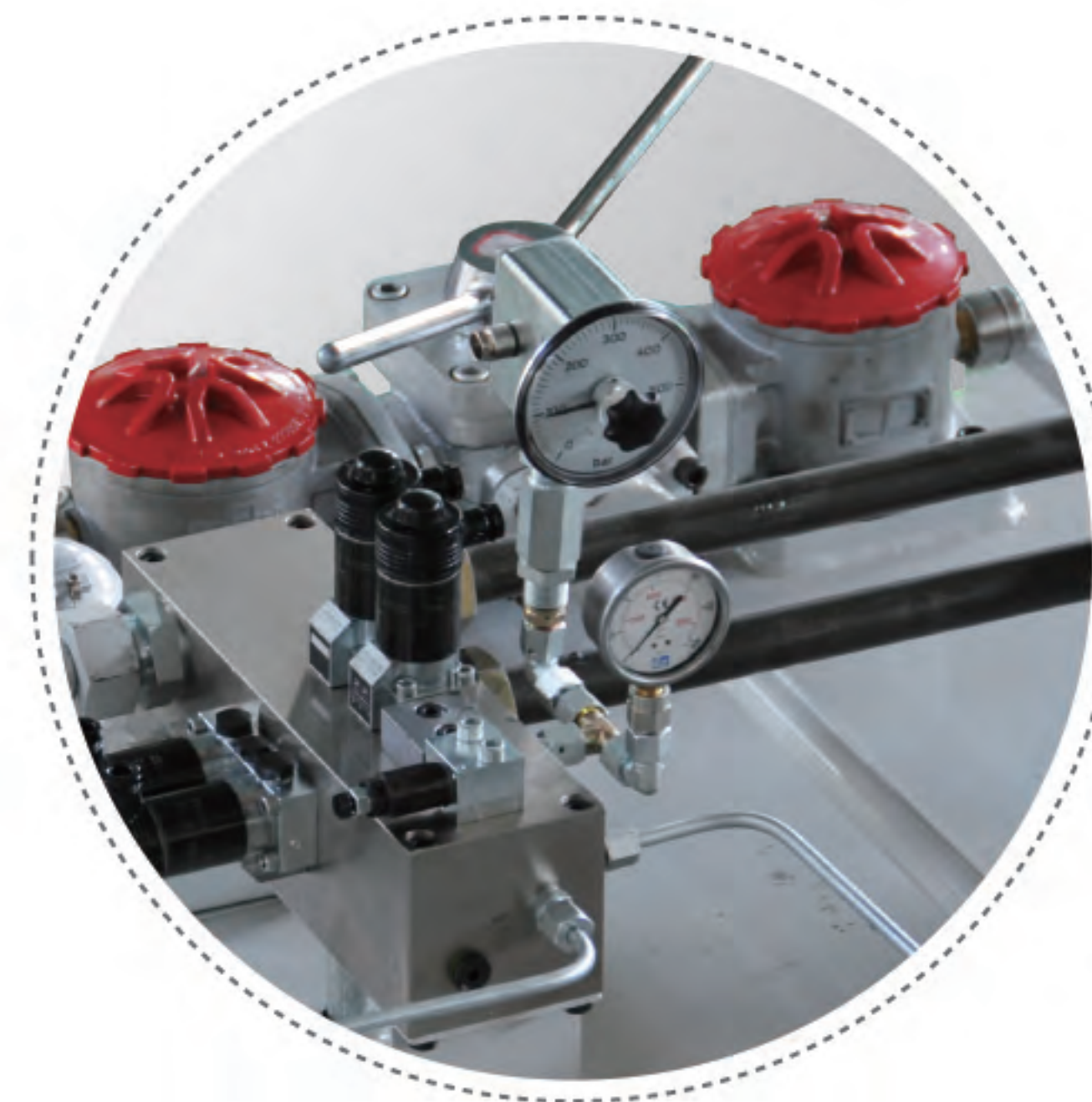

卡特彼勒液压缸测试系统

Hydraulic cylinder testing system for
CATERPILLAR

伺服阀流量: 150L/min 系统压力: 42MPa
系统总功率: 100KW 过滤器精度: 3 μm

Flow of Servo Valve: 150L/min
System Pressure: 42MPa
Total Output: 100KW
Precision of Filter: 3μm



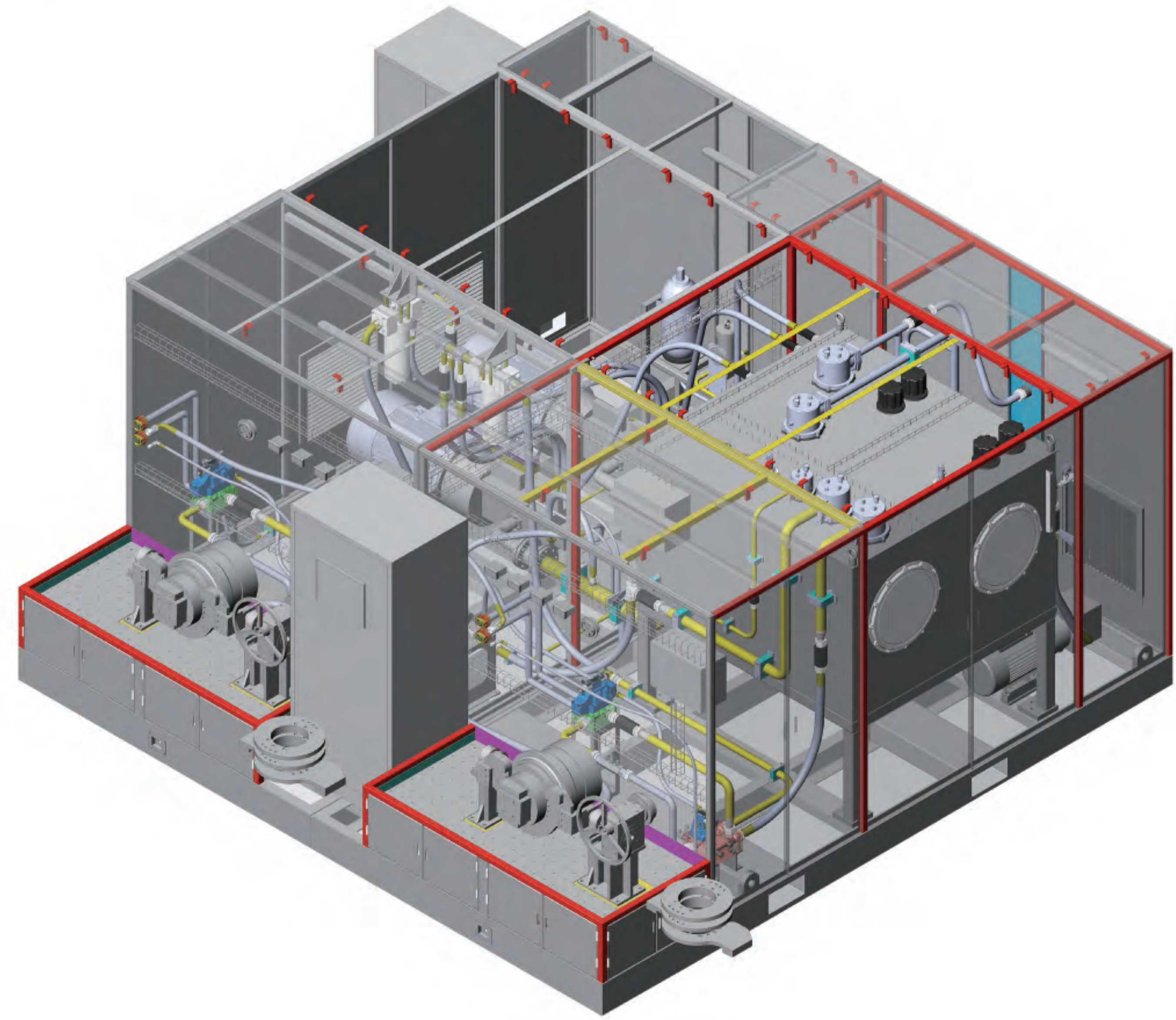

马达跑合测试台 Hydraulic Motor experimental platfor

- 压力 / Pressure: 42MPa
- 流量 / Flow: 300 L/min
- 液压闭式系统
- 尺寸: 4500x 4500x 2300 mm
- Pressure: 42MPa
- Flow: 300 L/min
- Hydraulic closed system
- Size: 4500x 4500x 2300 mm

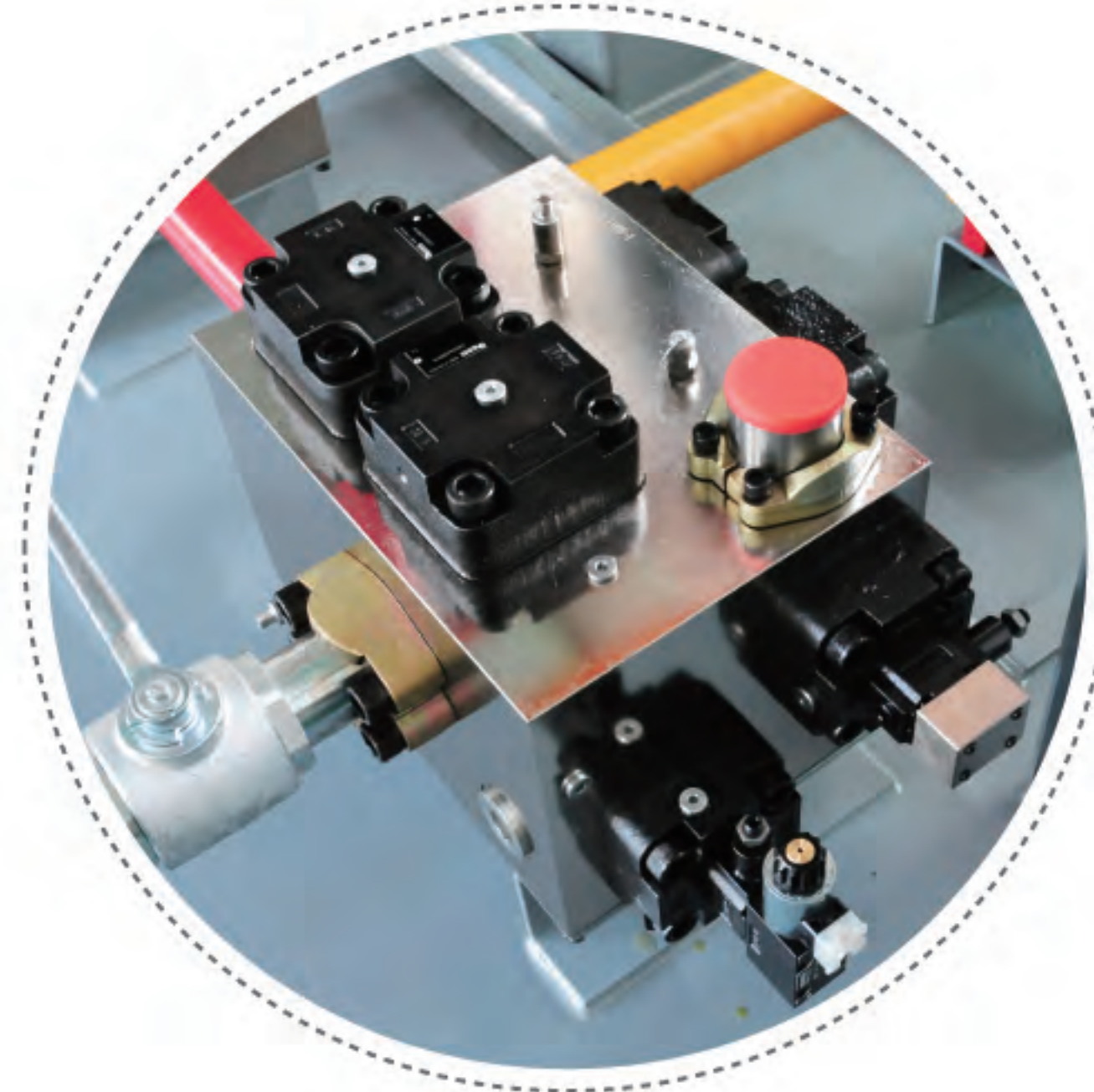

• 三一减速机局部

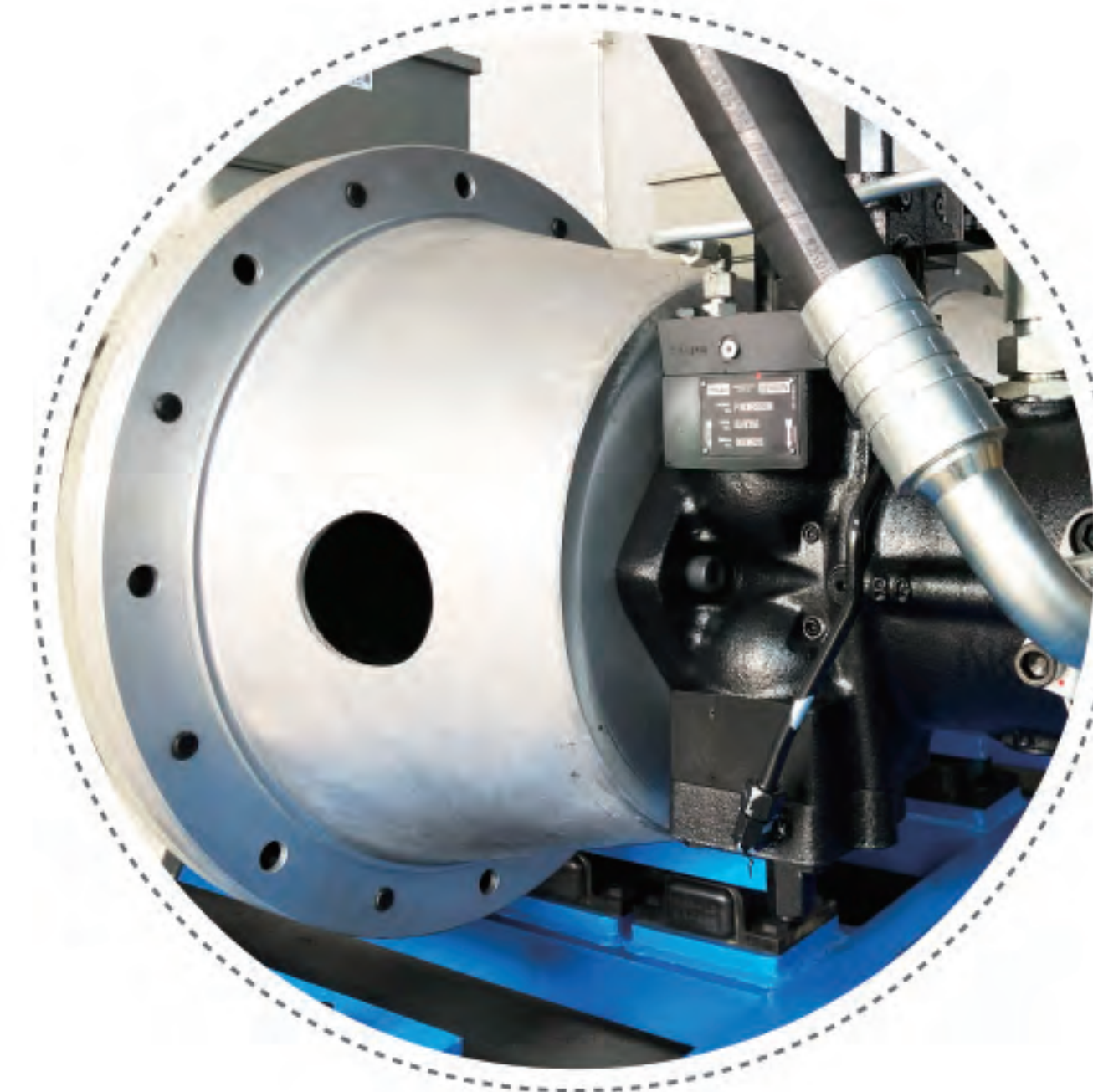

• 三一减速机局部

三一重机减速机测试台 / 回转支承测试台 Reducer / Slewing bearing experimental platfor

- 机械、电子、液压独立研发
- 压力 / Pressure: 42MPa
- 流量 / Flow: 750 L/min
- Independent design Including mechanical, electrical, hydraulic
- Pressure: 42MPa
- Flow: 750 L/min



• 仪表及电器操作面板
Operation panel of instruments and electrical appliances



• 正在测试的液压阀
Hydraulic valve that being tested

液压元件测试台 Hydraulic pressure experimental platfor

- Test benches for hydraulic valve
- Test benches for hydraulic pump
- Test benches for hydraulic motor
- Test benches for hydraulic cylinder
- Complete solutions for hydraulic testing and electrical control
- 液压阀测试台
- 液压泵测试台
- 液压马达测试台
- 液压缸测试台
- 液压测试及电控全套解决方案



发动机测试台

The engine experimental platfor

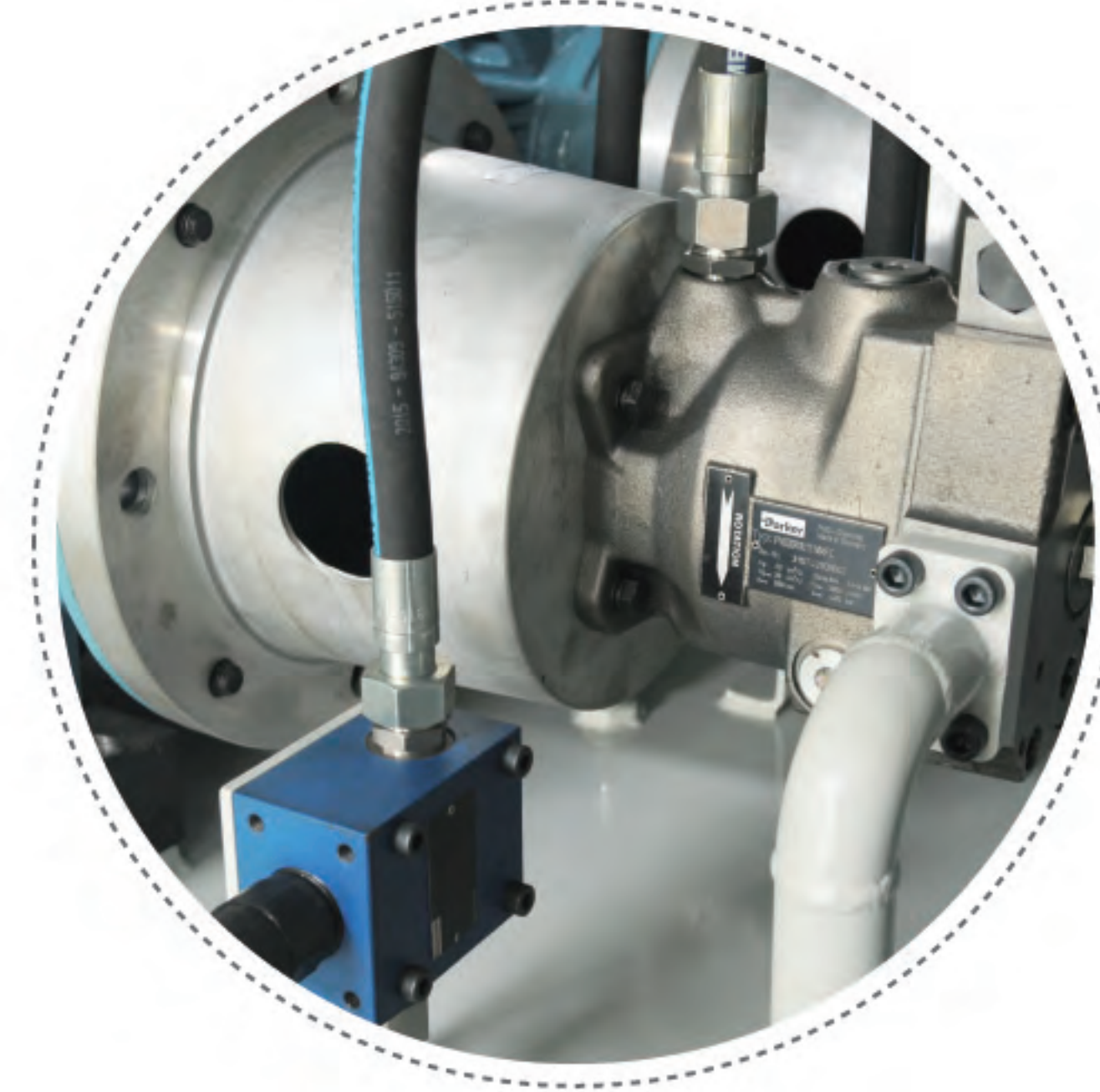

• 系统局部特写
Partial features of the system



• 系统局部特写
Partial features of the system

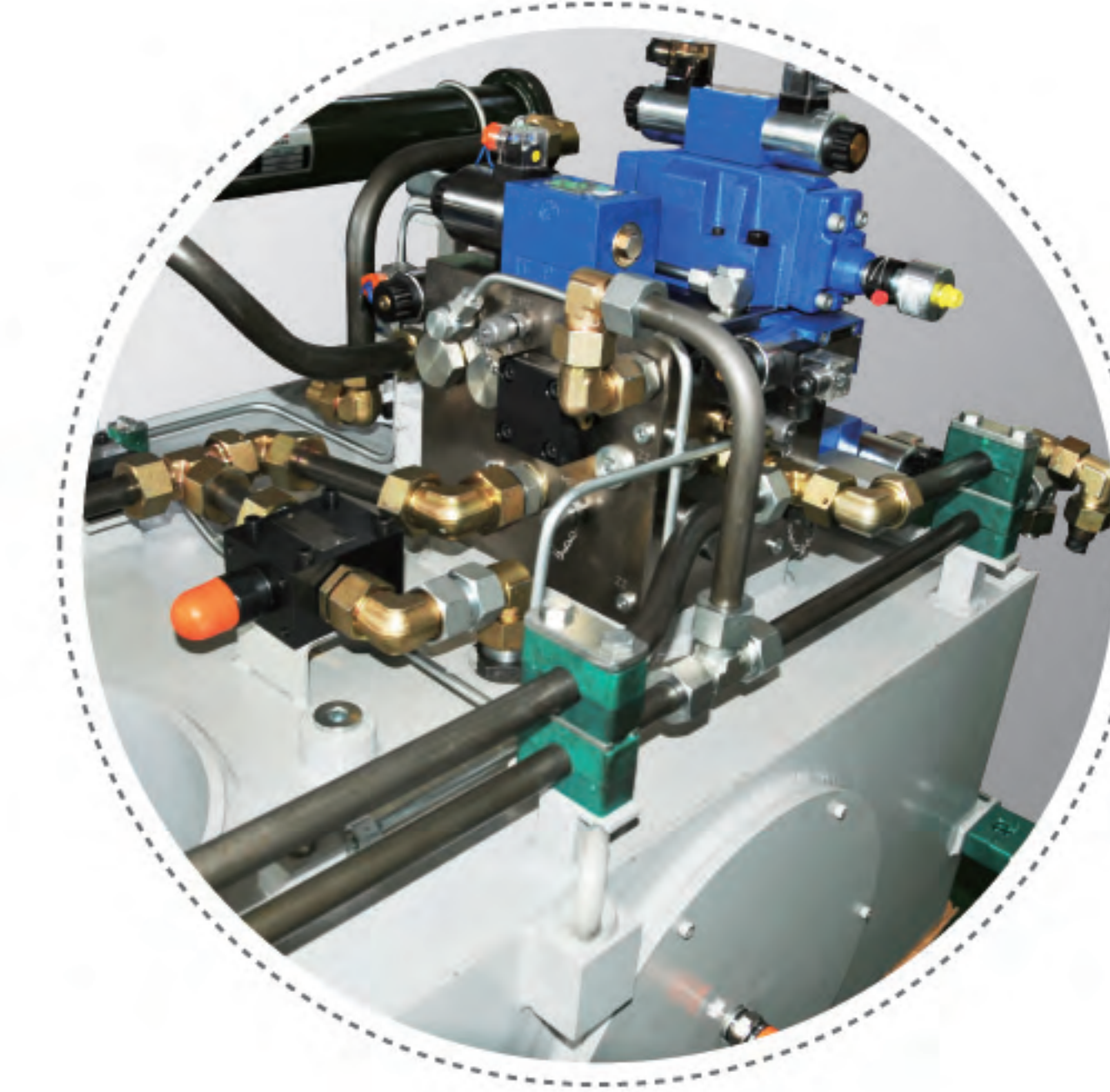

• 系统局部特写
Partial features of the system

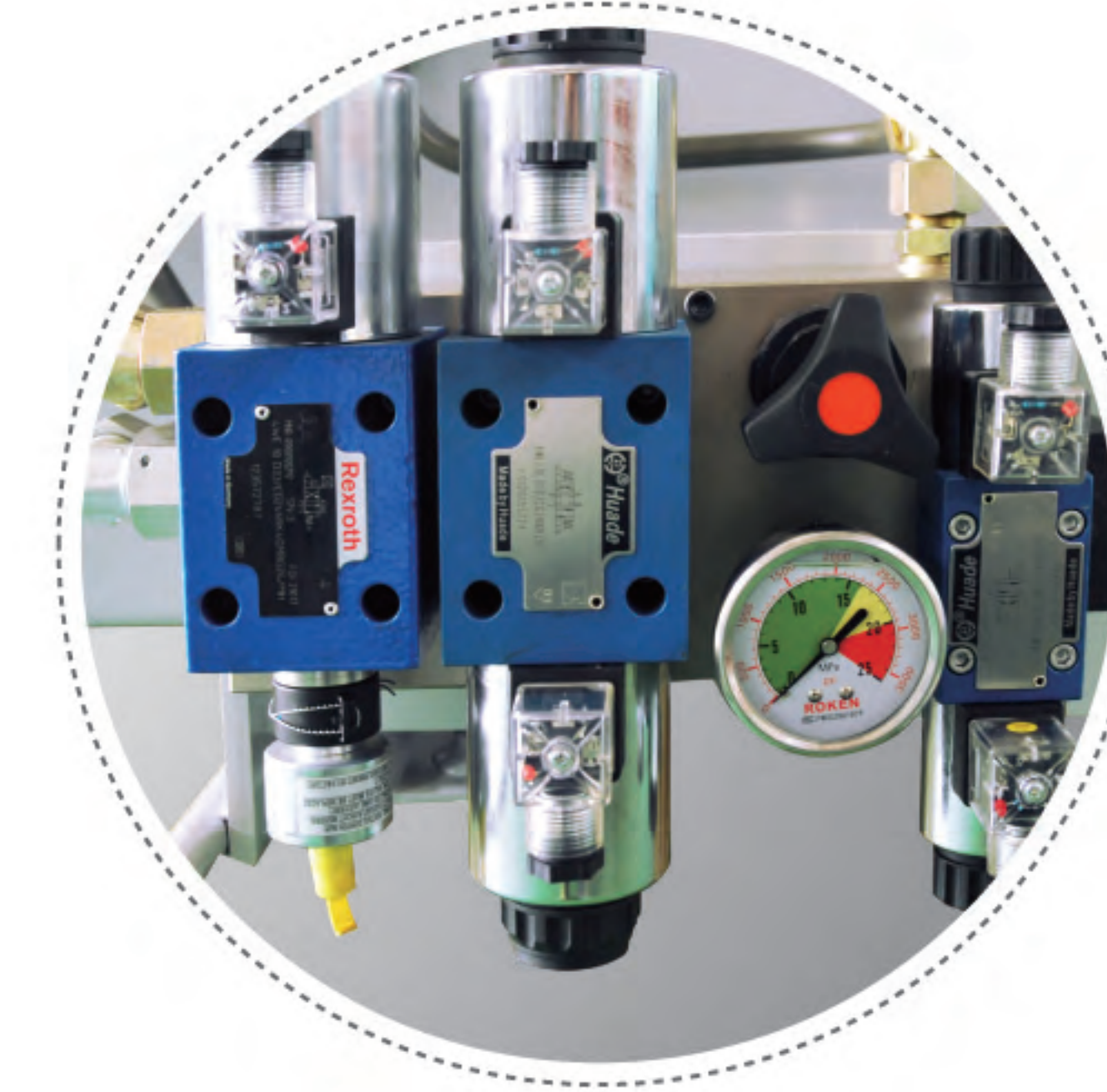

• 系统局部特写
Partial features of the system

库卡机器人液压系统

Hydraulic systems for KUKA robot

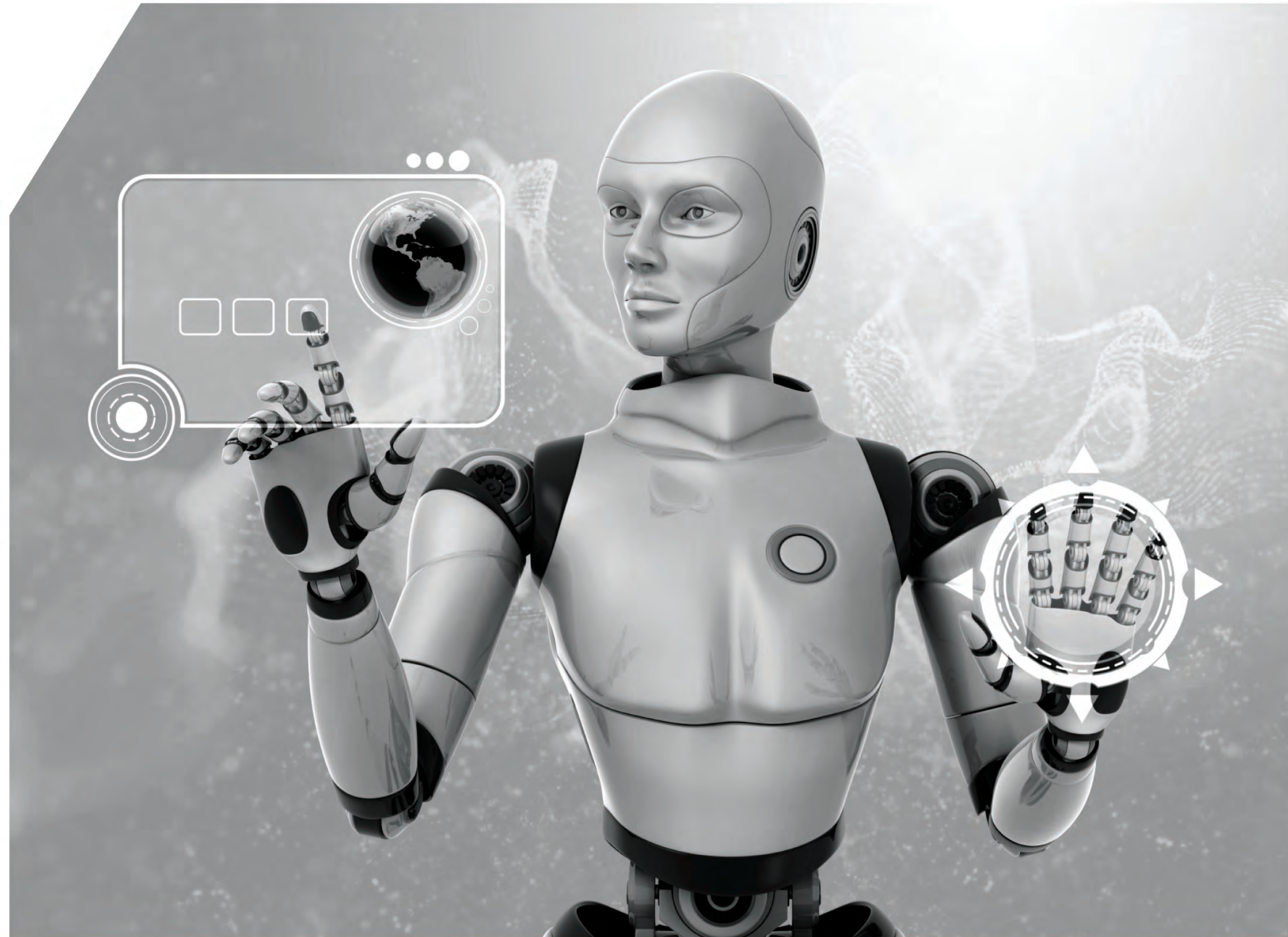
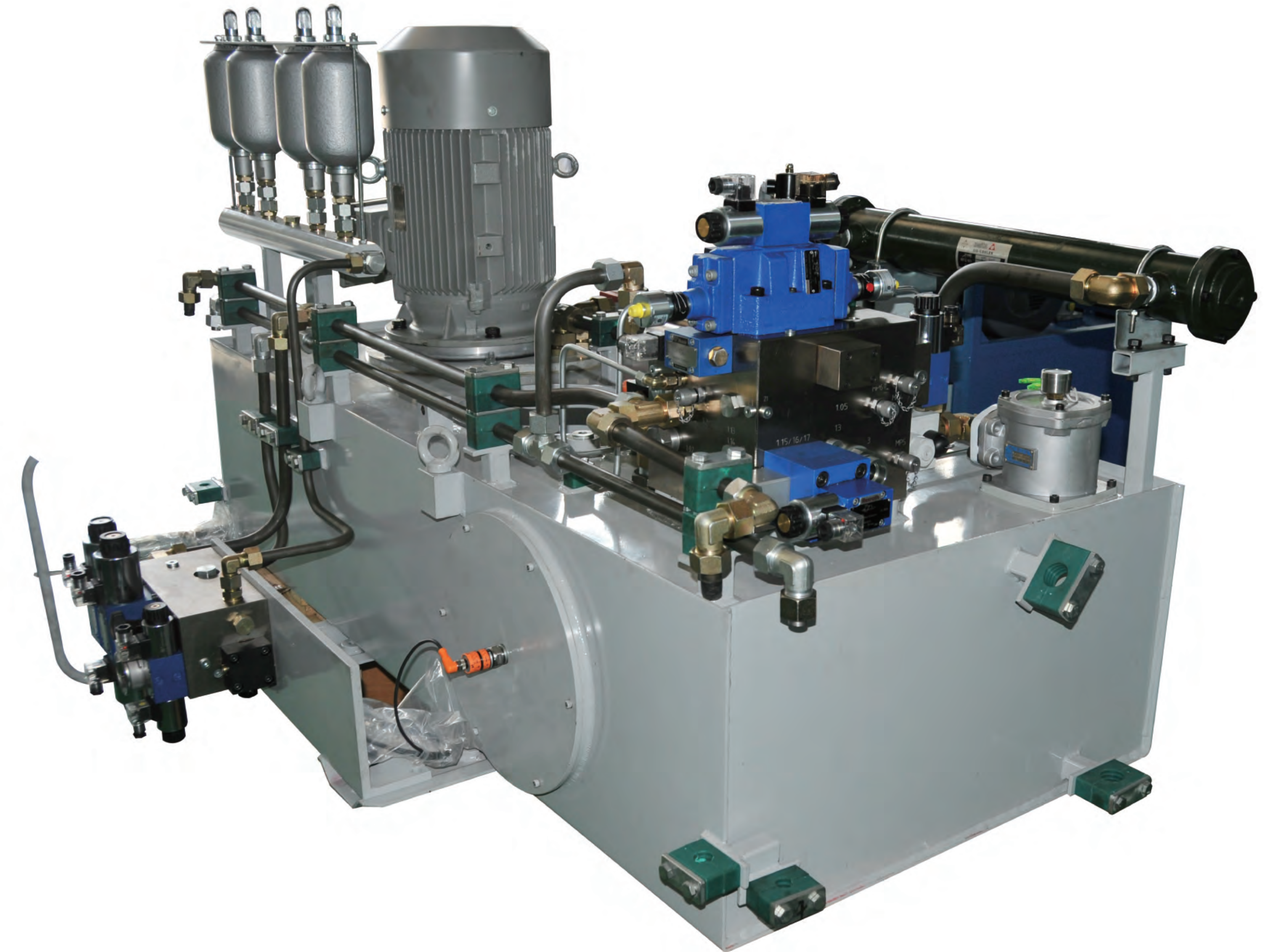



● 系统局部特写
Partial features of the system



● 系统局部特写
Partial features of the system

电器控制系统 Electrical control systems

根据用户需求，提供先进的电液集成智能化控制

- 集成PLC或PC控制系统
- 变频控制系统
- 伺服系统控制
- SCADAS监控系统（远程监控）
- 生产、安装、调试
- 维护和服务
- 软件

Providing advanced integrated electric-hydraulic intelligent control according to the customer's demands

- Integrated PLC or PC control system
- Frequency conversion control system
- Servo control system
- SCADAS monitoring system (remote monitoring)
- Production, installation and testing
- Maintenance and service
- Software

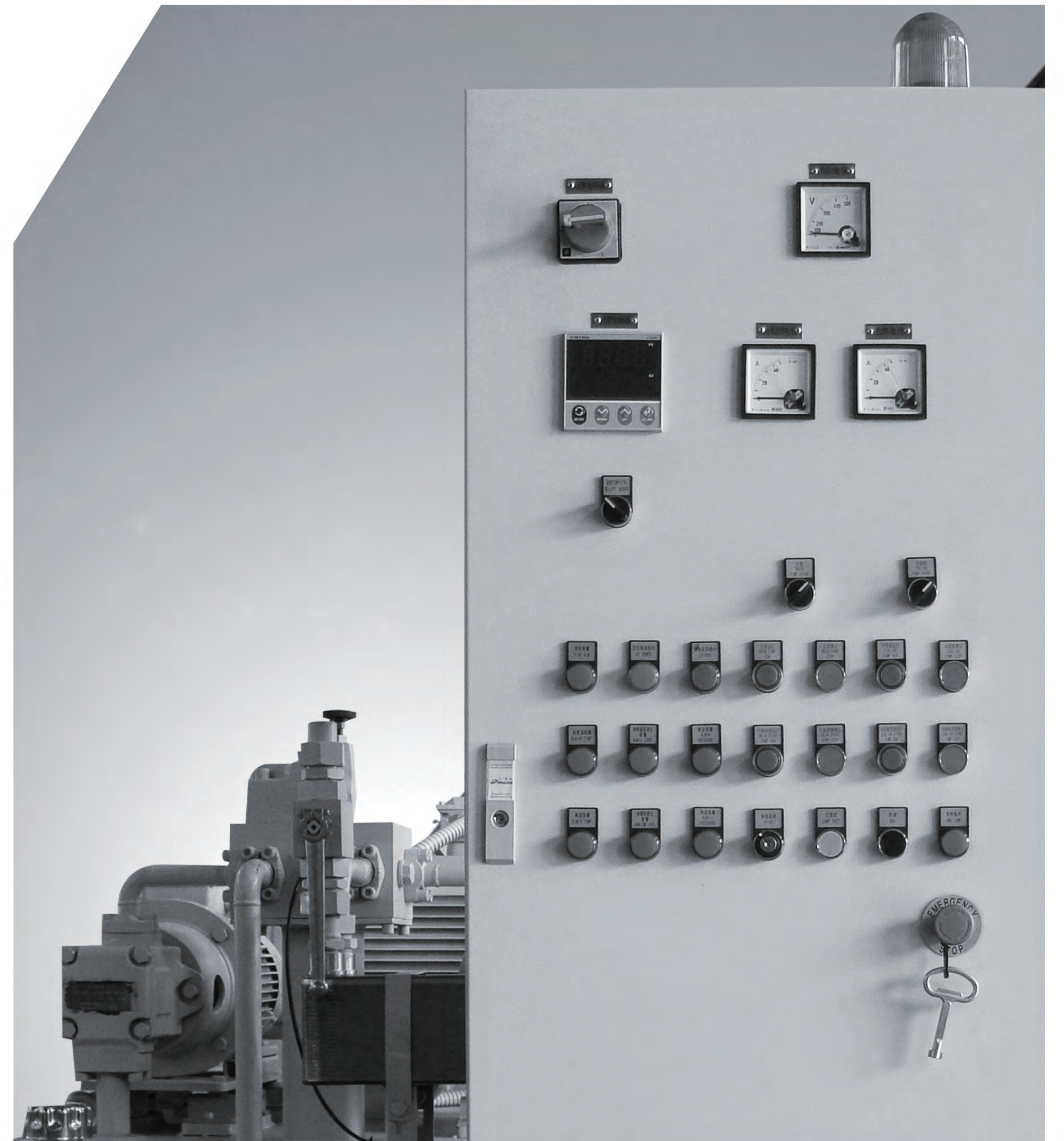



ROKEN provides various types of hydraulic cylinders that bore 28-1000, stroke under 12m and working pressure within 35 MPa, and also can design non-standard hydraulic cylinders or manufacture according to the drawing provided by the customers. Providing piston accumulators that gas capacity 1.0-39L, working pressure within 17MPa, also non-standard of working pressure within 35 MPa.

- Heavy-duty hydraulic cylinders Series CD250/CD350
- Vehicle hydraulic cylinders Series DG
- Engineering hydraulic cylinders Series HSG
- Metallurgical hydraulic cylinders Series Y-HG
- Four rods hydraulic cylinders
- Compact hydraulic cylinders
- Oscillating hydraulic cylinders
- Special purpose hydraulic cylinders
- Piston accumulators



• 车辆用液压缸DG系列
Vehicle hydraulic cylinders Series DG



• 冶金用液压缸Y-HG系列
Metallurgical hydraulic cylinders Series Y-HG



• 薄型液压缸CYB系列
Compact hydraulic cylinders Series CYB

液压缸 Hydraulic cylinders

ROKEN公司提供缸径 $\Phi 28\sim\Phi 1000$ 、行程12m以下内、工作压力35MPa以内的各类型液压缸，也可为用户设计非标液压缸或按用户提供图纸生产。提供气体容量1.0~39L、工作压力17MPa内的活塞式蓄能器，也可为用户提供工作压力35MPa以内的非标活塞式蓄能器。

- 重载型液压缸CD250/CD350系列
- 车辆用液压缸DG系列
- 工程用液压缸HSG系列
- 冶金用液压缸Y-HG系列
- 四拉杆液压缸
- 薄型液压缸
- 摆动缸
- 特殊用途液压缸
- 活塞式蓄能器



• 工程用液压缸HSG系列
Engineering hydraulic cylinders Series HSG

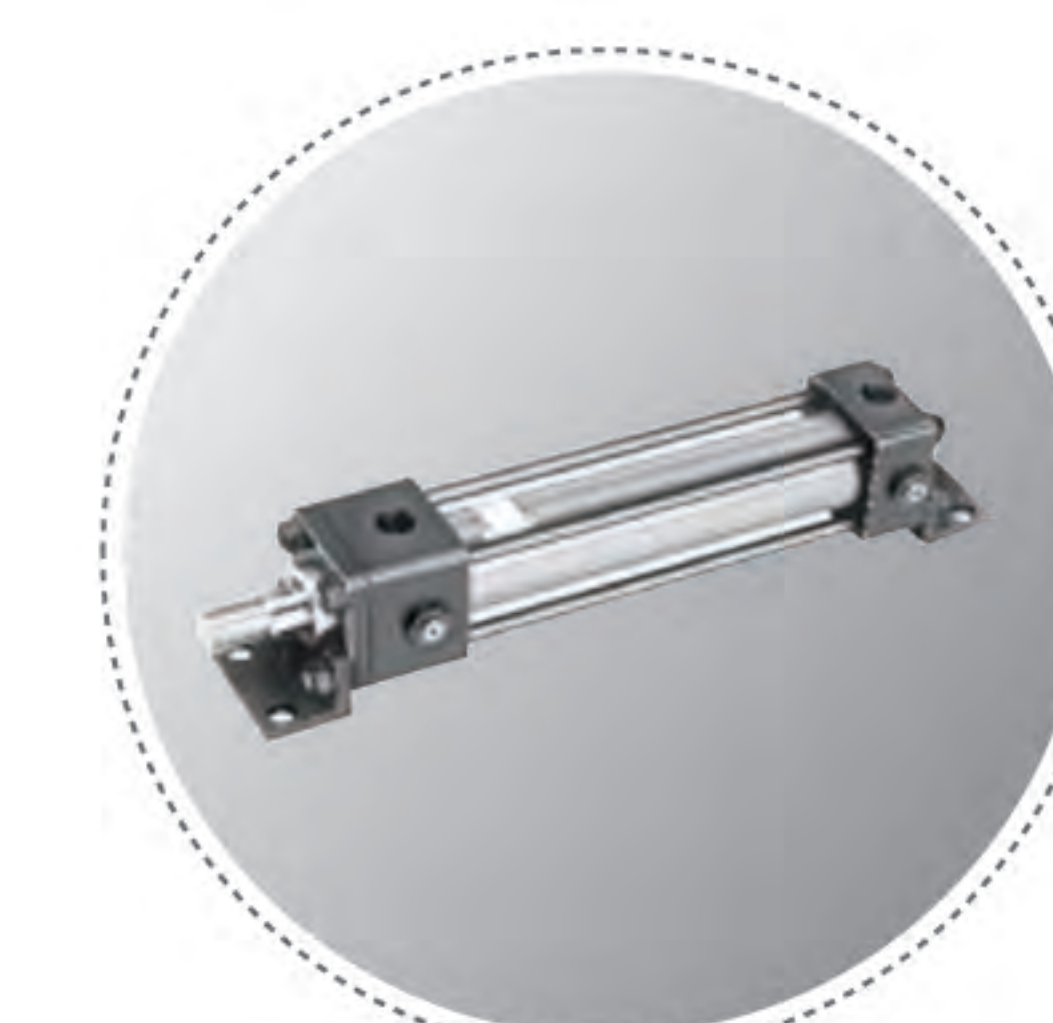

• 四拉杆液压缸CJT系列
Four rods hydraulic cylinders Series CJT



• 特殊用途液压缸
Special purpose hydraulic cylinders



● 钟型罩
Bellhousings



● 联轴器
Couplings



● 管接头及法兰接头
Pipe couplings and flange couplings

辅件 Accessories

铸铁钟型罩

铸铁钟型罩用于连接IEC标准电机和液压泵，我公司提供的铸铁钟型罩有如下特点：

- 钟型罩材料采用球墨铸铁，柔性好
- 两端连接法兰均经机加工，可连接ISO标准安装尺寸的液压泵，备有大量库存
- 电机轴和液压泵轴自动对中
- 可用于重负荷
- 用户订货时，只需提供电机和液压泵型号即可

铝质钟型罩

铝质钟型罩用于连接IEC标准电机和液压泵，我公司提供的铝质钟型罩有如下特点：

- 库存有各种规格的钟罩，适用于各种液压泵
- 两端连接法兰均经机加工
- 电机轴和泵轴自动对中
- 可用于重负荷
- 大多数钟罩可叠放

ROTEX 联轴器、梅花联轴器

- 钢制轴套，特别适合高载荷的驱动单元
- 扭向弹性、免维护
- 轴向插入式安装
- 吸收振动
- 失效保护
- 良好的动态特性
- 设计紧凑、惯性小
- 表面磷化处理

管接头及法兰接头

符合SAE J518/ISO6162 和 JB/ZQ4187-97 标准

Cast iron bellhousings

Used as the links between IEC motor and pump. Features:

- Made of nodular cast iron with fine flexibility.
- Both flange sides are finish machined and can connect the hydraulic pump with the ISO standard installation dimensions.
- For almost every bellhousing either available from stock or in short term
- Motor and pump shaft centered
- Designed for high loads
- When ordering, only need to provide the model of motor and hydraulic pump.

Aluminum bellhousings

Used as the links between IEC motor and hydraulic pump. Features:

- All types are available from stock and suitable for all kinds of hydraulic pumps
- Both flange sides are finish machined
- Motor and pump shaft centered
- Designed for high loads
- In many cases ROKEN bellhousings can be piled up

ROTEX couplings & plum couplings

- Designed for driving unit of high load with steel shaft sleeve
- Torsionally flexible--maintenance free
- Axial plug-in - easy assembly
- Absorbing shocks
- Fail-safe
- Good dynamical features
- Compact and low mass moments of inertia
- Surface phosphating process

Pipe couplings and flange couplings

In line with SEA J518/ISO6162 OR JB/ZQ4187-91

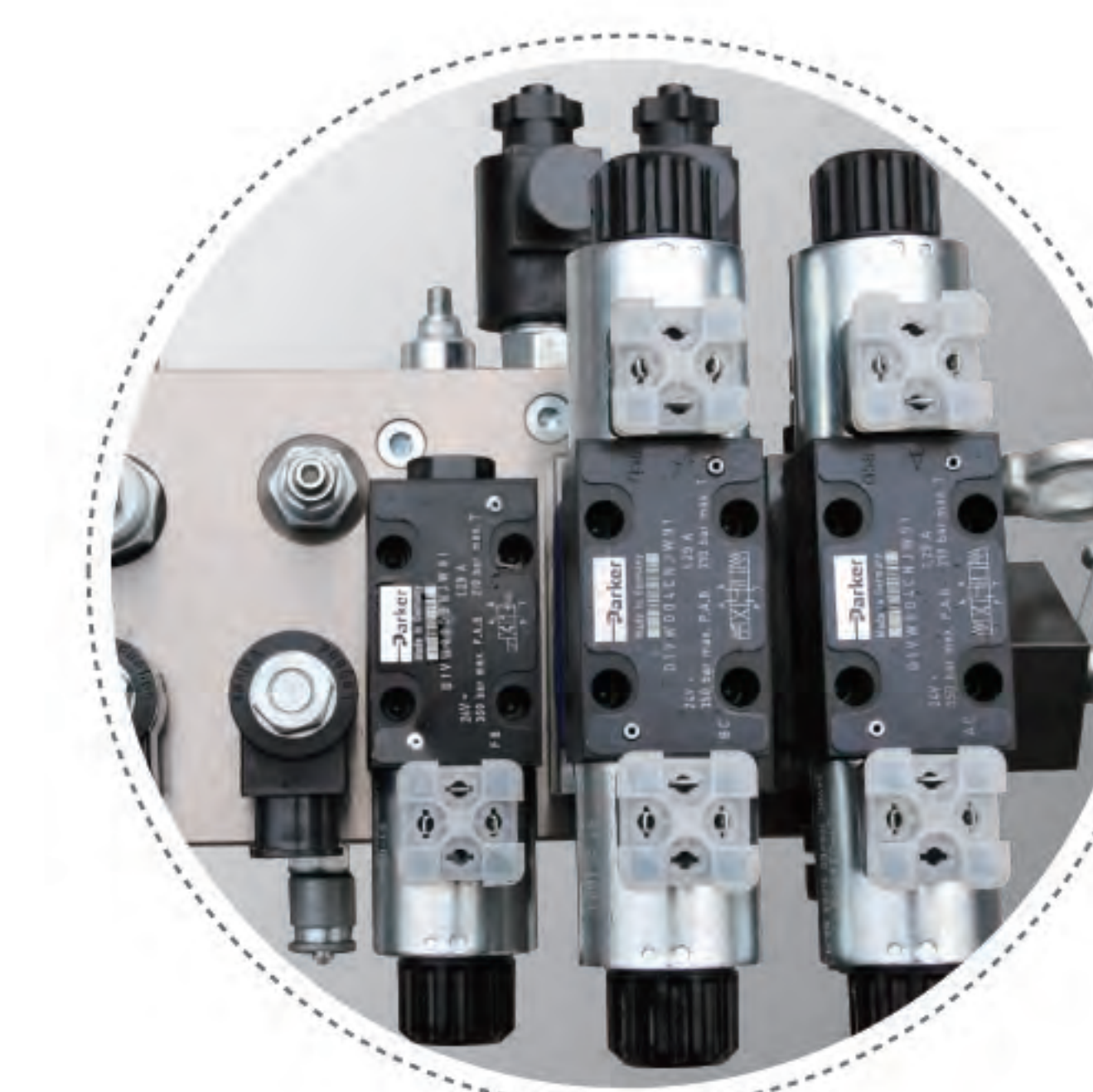

液压集成阀组件 Hydraulic manifolds

- RMC系列安装板的装配面符合ISO4401和CETOP RP121H标准
- 可根据液压回路，叠装叠加阀和电磁换向阀
- 适用液压系统的多样化和合理性而不用管道连接
- 最多可叠加10组叠加阀和电磁换向阀
- 可水平或垂直安装
- 环境温度：-20℃~+70℃
- 介质：液压油，符合DIN51524...535标准，用其它介质和我们技术部联系
- 介质清洁度：符合NAS1638 7级精度，建议用25μm，β25≥75的进油过滤器
- 可按用户要求订制

- Fitting surface of series RMC mounting panel is accord with the standard of ISO 4401 and CETOP RP121H
- Stacking the modular valves and solenoid directional valves up to 10 sets according to the different hydraulic circuit
- Not connected by pipeline to realize the variety and rationality of the systems
- Mounted vertically or horizontally
- Working temperature:-20℃~+70℃
- Medium: hydraulic oil that is accord with DIN 51524...535. If want to use other medium, please contact the technical department
- Cleanliness of medium: Be accord with NAS1638 level 7 accuracy. Inlet filter of 25μm, β25≥75 is usually recommended
- Customized according to the customer's requirements

中国南极科考队低温加油泵站和雪橇

Refueling pump stations under the low temperature and sledges for chinese antarctic scientific expedition



- Manufacturing refueling pump stations under the low temperature for chinese antarctic scientific expedition
- Manufacturing sledges for chinese antarctic scientific expedition
- Manufacturing structural houses, equipments and appliances for deep ice core drilling site of kunlun station of chinese antarctic scientific expedition

- 为中国南极科学考察队制作低温工况加油泵站
- 为中国南极科学考察队制作雪橇
- 为中国南极科学考察队昆仑站深冰芯钻探场地制作结构房屋及设备器材



• 南极实地应用图片
Site application



• 南极实地应用图片
Site application

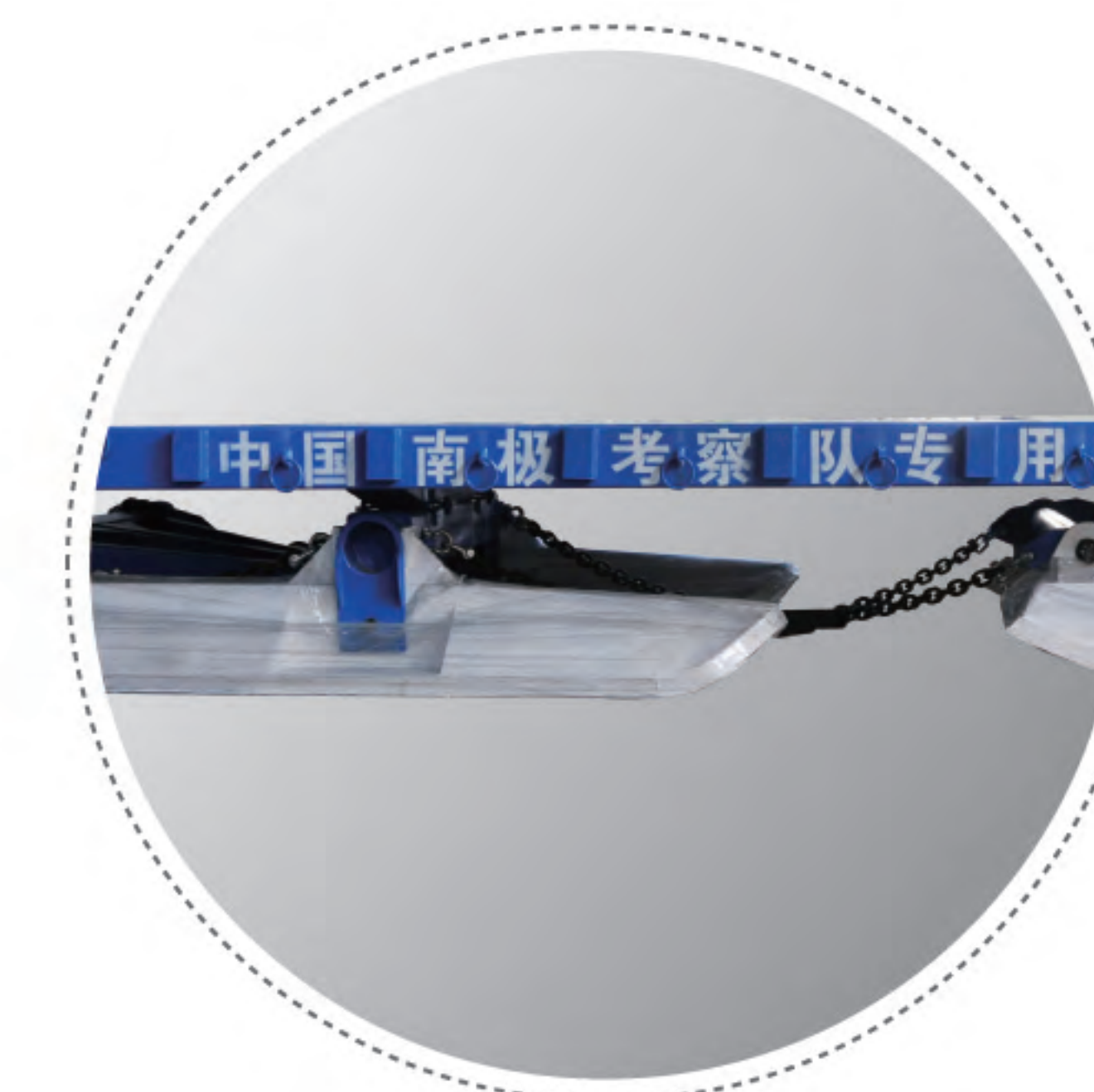

• 局部特写
Partial features



• 低温加油泵
Refueling pump under the low temperature

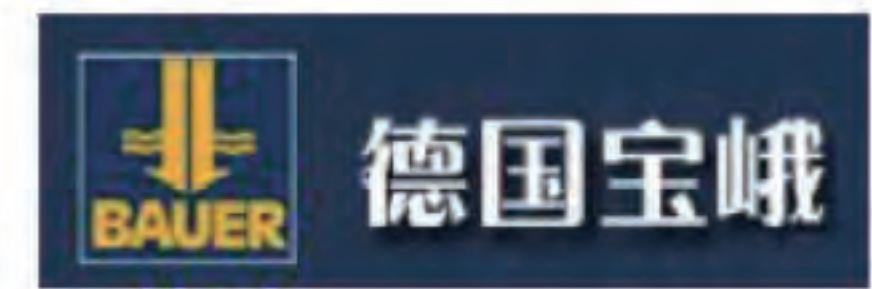
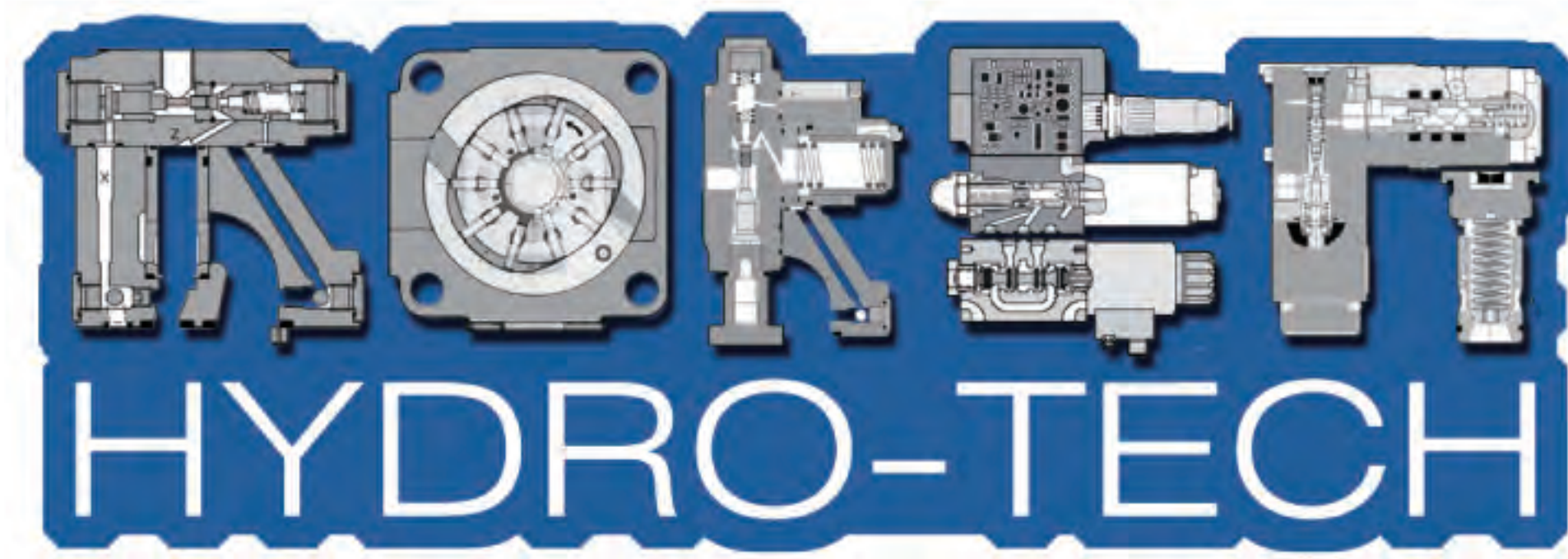

典型案例:

德国蒂森克虏伯配套液压系统
 德国安格综合液压伺服测试系统 (机电液总包)
 德国博可电路板层压机配套液压系统
 德国爱尔玲密封件成型机 (机电液总包)
 德国路拓配套液压系统
 德国库卡液压系统配套
 德国史杰西加热炉配套液压系统
 德国科赫冶金机械配套液压系统
 德国汉萨福莱克斯液压油箱配套
 德国宝峨工程机械液压测试系统;
 比利时贝卡尔特液压系统配套
 美国罗宾斯盾构机配套液压系统
 美国江森自控液阀配套
 美国通用电气液压测试系统
 美国博格华纳液压测试系统
 美国萨帕铝热传输生产线配套液压系统
 美国卡特比勒液缸及减速机测试系统;
 美国英格索兰空压机测试系统;
 美国派克液箱配套
 日本油研液压系统OEM配套
 日本会田锻压机配套液、润滑系统
 日本碍子陶瓷压机配套液压系统
 日本电产压机配套液压系统
 日本生田机械铜带生产线的集中冷却、润滑站配套项目;
 中广核项目综合测试系统 (机电液总包)
 中核工业综合测试系统 (机电液总包)
 中国工程物流研究院压机配套电气液压系统
 中国极地研究中心南极雪地车航空煤油输油泵站的配套项目
 中国极地研究中心重型雪橇配套项目
 中船11研究所大连造船厂600T冷弯机液压系统配套;
 中船七一一研究所液测试台
 中冶集团东方设计院除尘液压系统
 航天八〇三所油泵综合测试台 (机电液总包)
 兵器工业辽沈工业集团公司液压系统配套;
 同济大学液压测试动力单元;
 上海工程技术大学冲床伺服试验台;
 振华重工集团液压系统配套
 润邦重机液压系统配套
 三一重工减速机/回转支撑测试系统 (机电液总包);
 龙工马达耦合测试系统
 海天塑机比例阀测试系统
 新松机器人液系统配套;
 无锡恒立液缸测试台 (机电液总包);
 长沙中联重科集团固废处理设备液压系统配套;
 中集固废处理设备液压系统配套;
 北玻集团玻璃设备液压系统配套
 江阴法尔胜液系统配套;
 远东宏信地下工程设备液压系统配套;
 华澳轮胎设备公司轮胎定型硫化机配套液压系统
 华强方特文化G自由度动感影院配套伺服液系统

CLIENT CASES:

thyssenkrupp
 VAG-Armaturen GmbH
 Robert burkle GmbH
 elring-klinger AG
 ROTODECOR GmbH
 KUKA Robots AG
 Striko-Westofen
 KOHE
 HANSAFLEX
 BAUER
 BEKAERT
 Robbins
 Johnson Controls
 GE
 BorgWarner
 sapa
 CATERPILLAR
 Ingersoll Rand
 PARKER
 YUKEN
 AIDA
 NGK
 Nidec
 Ikuta
 China General Nuclear Power Corporation
 China National Nuclear Corporation
 China Academy of Engineering Physics
 Polar Research Institute of China
 China State Shipbuilding Corporation Limited
 CSIC 711 Research Institute
 China Metallurgical Group Corporation
 China Aerospace Science and Technology Corporation
 China North Industries Group Corporation Limited
 Shanghai Tongji University
 Shanghai University of Engineering Science
 Shanghai Zhenhua Heavy Industries Co., Ltd.
 Nantong Rainbow Heavy Machineries Co., Ltd.
 SANY Group
 LONKING Group
 HAITIAN Group
 SIASUN Robots
 Hengli Corporation
 Zoomlion Corporation
 China International Marine Containers (Group) Ltd. (CIMC)
 NorthGlass
 Jiangsu Fasten Co., Ltd.
 Far East Horizon Ltd.
 SINO-ARP Tires Equipment Technology (Suzhou) Co., Ltd.
 FANTAWILD Holdings Inc.